



**ACG+**

User Manual

Commercial in Confidence

The ACG+ must be returned to Analox in its original storage and transit case.

Failure to do so may result in damage which will be chargeable.

**UK Office**

15 Ellerbeck Court,  
Stokesley Business Park,  
North Yorkshire, TS9 5PT, UK



**US Office**

15121 Graham Street #B106,  
Huntington Beach, California,  
92649

**UK / Global**

info@analox.biz  
+44 (0)1642 711 400  
+44 (0) 1642 713 900



**US Office**



ussales@analox.biz  
(714) 891 4478  
Toll Free: (877) 723 3247  
(714) 891 4479



## **Table of Contents**

<b>1</b>	<b>Contents checklist</b>	<b>8</b>
1.1	Standard contents	8
1.2	Optional accessories	8
<b>2</b>	<b>Safety information</b>	<b>9</b>
2.1	Capabilities to test gases against the EN 12021:2014 standard	9
2.2	Electrochemical sensors (oxygen and carbon monoxide)	9
2.3	PID lamp cleaning kit	10
2.4	Inlet pressure & flow	10
<b>3</b>	<b>Introduction</b>	<b>11</b>
3.1	ACG+ overview	11
<b>4</b>	<b>Installation details</b>	<b>13</b>
4.1	Mechanical overview	13
4.2	Gas sample connection (Both fixed and portable versions)	14
4.3	Installation (Portable)	15
4.4	Installation (Fixed)	17
4.5	Safety interlock relay (ACG+ Fixed)	20
4.6	Safety interlock override key-switch (ACG+ Fixed)	21
4.7	Switched 24V DC outputs (ACG+ Fixed)	22
<b>5</b>	<b>Operating instructions</b>	<b>23</b>
5.1	Start-up	23
5.2	Controls	24
5.3	Inlet/purge valve	25
5.4	Display	26
5.5	Menu	27
5.6	Adjusting the backlight	28
5.7	Power sub-menu	29
5.8	System flow	29
5.9	Sensor readings	30
5.10	Alarms	32
5.11	Clearing alarms and hysteresis	33
5.12	Calibration adjustment	37
5.13	Viewing device information	44
5.14	Viewing sensor information	44
5.15	Data-logging	45
5.16	Sensor replacement reminder	48
5.17	Timed sample draw	49
5.18	Setting the date and time	53
<b>6</b>	<b>Configuration</b>	<b>54</b>
6.1	Software installation	54
6.2	Making a connection	57
6.3	Changing options	59
6.4	Downloading data-logs	60
6.5	Setting the time	61
<b>7</b>	<b>Networking</b>	<b>62</b>
7.1	Overview	62
7.2	Connection	62
7.3	Transmission method	62
7.4	Setting the ACG Static IP Address	63
7.5	Retrieving Data using TCP/IP Requests	63
7.6	Retrieving Data using UDP	64
7.7	Datagram Structure	64
<b>8</b>	<b>Troubleshooting</b>	<b>70</b>
8.1	System faults	70
<b>9</b>	<b>Recommended spares and accessories</b>	<b>75</b>

9.1 Service requirements ..... 77

**10 Maintenance requirements ..... 78**

10.1 Sensor & filter replacement ..... 78

10.2 Filter replacement ..... 91

10.3 Service requirements ..... 92

**11 Specifications ..... 99**

11.1 Instrument specification ..... 99

11.2 Sensor specification ..... 100

**12 UK Declaration of Conformity .....101**

**13 Declaration of conformity .....102**

## List of figures

Figure 1	ACG+ Overview .....	11
Figure 2	ACG+ Mechanical Overview .....	13
Figure 3	Typical ACG+ Portable Installation.....	15
Figure 4	Typical ACG+ Fixed installation .....	17
Figure 5	Connector Locations .....	18
Figure 6	ACG+ Power .....	19
Figure 7	Typical Interlock Relay Wiring.....	20
Figure 8	Typical Use of Switched 24V Outputs .....	22
Figure 9	Start-Up Splash Screen.....	23
Figure 10	ACG+ Front Panel.....	24
Figure 11	Main Display Overview .....	26
Figure 12	System Status Indicator.....	27
Figure 13	The Main Menu .....	27
Figure 14	The Backlight Sub-Menu.....	28
Figure 15	Power Sub-Menu .....	29
Figure 16	Example of a Sensor that is in a Warm-Up State .....	31
Figure 17	Sensor Bar Graph Indicator.....	31
Figure 18	Degraded State Sensor Bar Graph Indicator .....	31
Figure 19	Out Of Display Range Bar Graph Indicators .....	31
Figure 20	Sensor in Fault Bar Graph Indicator .....	32
Figure 21	A Low-Going Alarm That Has Been Triggered .....	32
Figure 22	Mute Button .....	32
Figure 23	Hysteresis Band on a High Going Oxygen Alarm .....	33
Figure 24	Selecting a CO <sub>2</sub> Alarm to Adjust .....	35
Figure 25	Example of Alarm Set-Point Adjustment .....	36
Figure 26	Flow Regulator Fitted to Calibration Bottle .....	39
Figure 27	Connecting Calibration Fitting to ACG+ Calibration Port .....	39
Figure 28	Calibration Adjustment Screen Showing High Calibration Bottle ....	40
Figure 29	Calibration Adjustment Results - CO <sub>2</sub> Sensor Failed to Adjust.....	41
Figure 30	Excluding the VOC Sensor from the Calibration Adjustment.....	42
Figure 31	Adjusting the CO <sub>2</sub> Calibration Value .....	43
Figure 32	Calibration Adjustment Reminder .....	43
Figure 33	Device Information Screen.....	44
Figure 34	Sensor Information Screen for O <sub>2</sub> .....	44
Figure 35	Data-Log Download Screen .....	46
Figure 36	Data-Log Download in Progress .....	46
Figure 37	Sensor Change Reminder .....	48
Figure 38	Sensor Replacement Reset Confirmation Screen .....	49
Figure 39	A Dräger Impactor Attached to the Outlet Port for Oil Mist Testing	51
Figure 40	Timed Sample Setup .....	52
Figure 41	Timed Sample Progress.....	52
Figure 42	Date And Time Adjustment Screen .....	53
Figure 43	ACG+ Software without Device Connected .....	57
Figure 44	Connecting a USB Cable to an ACG+.....	57
Figure 45	ACG Software with Device Connected Showing General Options ....	59
Figure 46	The Data Logs Available on a Connected ACG+ .....	60
Figure 47	Downloading Data Logs from an ACG+ .....	61
Figure 48	Setting the Date and Time on an ACG+ .....	61
Figure 49	System Showing a Fault Condition .....	70

**List of tables**

<b>Table 1</b>	<b>Electrochemical sensor first aid procedures .....</b>	<b>9</b>
<b>Table 2</b>	<b>Connector J17 Pin Assignments.....</b>	<b>18</b>
<b>Table 3</b>	<b>Connector J3 Pin Assignments.....</b>	<b>19</b>
<b>Table 4</b>	<b>Relay and 24V Output Operation under Fault and Alarm Conditions..</b>	<b>21</b>
<b>Table 5</b>	<b>Sensor Status Icons.....</b>	<b>30</b>
<b>Table 6</b>	<b>Scaled Hysteresis Values .....</b>	<b>33</b>
<b>Table 7</b>	<b>Recommended Calibration Gas Concentrations.....</b>	<b>37</b>
<b>Table 8</b>	<b>Data-Log Formatting Example .....</b>	<b>45</b>
<b>Table 9</b>	<b>List of System Faults and Possible Solutions .....</b>	<b>71</b>
<b>Table 10</b>	<b>List of Sensor Faults and Possible Solutions .....</b>	<b>72</b>
<b>Table 11</b>	<b>List of Spares.....</b>	<b>75</b>
<b>Table 12</b>	<b>List of Accessories .....</b>	<b>76</b>
<b>Table 13</b>	<b>6 monthly service for ACG+.....</b>	<b>77</b>
<b>Table 14</b>	<b>12 monthly service for ACG+.....</b>	<b>77</b>
<b>Table 15</b>	<b>24 monthly service for ACG+.....</b>	<b>77</b>
<b>Table 16</b>	<b>Maintenance Schedule of ACG+ Components.....</b>	<b>78</b>
<b>Table 17</b>	<b>Service Schedule of ACG+ Components .....</b>	<b>92</b>

## Warnings, Cautions and Notes

Warnings and Cautions are used in this Manual to highlight potential hazards and safety risks. Notes are used to provide supplementary information that is not hazard-related.



**WARNING:** THIS INDICATES A POTENTIALLY HAZARDOUS SITUATION THAT, IF NOT AVOIDED, COULD RESULT IN DEATH OR SERIOUS INJURY.



**CAUTION:** THIS INDICATES A POTENTIALLY HAZARDOUS SITUATION THAT, IF NOT AVOIDED, COULD RESULT IN EQUIPMENT DAMAGE OR LOSS OF DATA.



**NOTE:** THIS INDICATES INFORMATION THAT IS CONSIDERED IMPORTANT BUT IS NOT HAZARD RELATED.

## **1 Contents checklist**

### **1.1 Standard contents**

Below is a list of standard contents which will be supplied to the customer

- a) ACG+ unit (Including transport case)
- b) USB lead
- c) 0.1l/m restrictor kit (For sampling using Oil mist colorimetric tubes)
- d) A printed copy of the user manual (A4 booklet)
- e) Software CD
- f) Test certificate

### **1.2 Optional accessories**

Below is a partial list of optional accessories which could be supplied to the customer depending on the order. The full spares & accessories list can be found on page 75.

- a) Li-Ion rechargeable battery pack kit (Includes battery mounting case & charger)
- b) NiMH rechargeable battery pack kit (Includes battery mounting case & charger)
- c) External PSU (If not using rechargeable battery pack option, connection via front panel)
- d) External PSU (For fixed installation using cable gland direct to interface PCB)
- e) External beacon (For fixed units only)
- f) Pressure regulator (2 stage)
- g) Humidifier (For when the ACG+ is in constant use)
- h) Mounting kit to install on either a solid wall or instrument panel (For fixed units only)
- i) Gland and Override Keyswitch kit (For fixed units only)

The humidifier (g) should be installed if the ACG+ is going to be continuously connected for over 12 hours to the compressed gas source with no exposure to ambient air. The humidifier is required to pull moisture from the ambient air to re-hydrate the electrochemical cells within the ACG+. If dry gas is constantly being passed over the sensors they will dry out and stop performing correctly.



## 2 Safety information



**WARNING: READ THE SAFETY INFORMATION FULLY BEFORE USING THE ANALOX ACG+.**

### 2.1 Capabilities to test gases against the EN 12021:2014 standard

The ACG+ is partially capable to test gases against EN 12021:2014.

The ACG+ can test the following gas types from the standard:

- Breathing air
- Oxygen compatible air
- Nitrogen depleted air

### 2.2 Electrochemical sensors (oxygen and carbon monoxide)

Electrochemical sensors contain toxic compounds. Under normal conditions the sensor will be safely sealed. To prevent leakage, the unit must not be exposed to temperatures outside the specified range, or be exposed to organic vapours, which may cause physical damage to the body of the sensor. The unit must not be stored in areas containing organic solvents or in flammable liquid stores.

When the life of the sensor has expired or it is leaking or otherwise damaged it must be disposed of safely in accordance with local regulations.

The carbon monoxide cell contains an acidic electrolyte (sulphuric acid) whilst the oxygen cell contains caustic electrolyte (potassium hydroxide). In the event of an accident, use the following first aid procedures.

**Table 1 Electrochemical sensor first aid procedures**

Body Part	Effect	First Aid Procedures
Skin	Contact could result in a chemical burn.  Persons with pre-existing skin disorders may be more susceptible to the effects of the substance.	Immediately flush the skin thoroughly with water for at least 15 minutes.  Remove contaminated clothing and wash before re-use.  Obtain medical advice if continued irritation.
Ingestion	Corrosive. May cause sore throat, abdominal pain, nausea, and severe burns of the mouth, throat, and stomach, and may be fatal.	If swallowed DO NOT INDUCE VOMITING.  Wash out mouth thoroughly with water and give plenty of water to drink.  Obtain medical advice immediately

<b>Body Part</b>	<b>Effect</b>	<b>First Aid Procedures</b>
Eye	<p>Persons with pre-existing eye problems may be more susceptible to the effects of the substance.</p> <p>Corrosive. May cause redness, pain, blurred vision, and eye burns.</p> <p>Contact can result in the permanent loss of sight.</p>	<p>Irrigate thoroughly with water for at least 15 minutes.</p> <p>Obtain medical advice immediately.</p>
Inhalation	<p>Persons with pre-existing impaired respiratory function may be more susceptible to the effects of the substance.</p> <p>Inhalation is not an expected hazard unless heated to high temperatures.</p> <p>Mist or vapour inhalation can cause irritation to the nose, throat, and upper respiratory tract.</p>	<p>Remove to fresh air.</p> <p>Rest and keep warm.</p> <p>Obtain medical advice if applicable.</p>

Should leakage of any electrolyte occur as a result of misuse, incorrect operation, manufacturing error, physical damage, etc. then wear protective gloves when cleaning any spills. Should electrolyte contact skin then the affected area should be washed thoroughly with copious water and medical advice sought if there has been any contact with the eyes or mouth. If connected to any electrical equipment, the sensor should be immediately removed.

## **2.3 PID lamp cleaning kit**

The PID lamp cleaning kit (9300-1022) contains a vial of cleaning compound which contains alumina (CAS Number 1344-28-1) as a very fine powder.

Hazard identification: May cause irritation of respiratory tract and eyes

Storage: Keep container closed to prevent water absorption and contamination

Handling:

- Do not breathe in the powder, avoid contact with skin, eyes and clothing
- Wear suitable protective clothing
- Follow industrial hygiene practices, wash face and hands thoroughly with soap and water after use and before eating, drinking, smoking or applying cosmetics
- The powder carries a TVL (TWA) limit of 10mg/m<sup>3</sup>

## **2.4 Inlet pressure & flow**

The system maximum inlet pressure is 10 bar gauge (145 psig). Ensure that appropriate pressure reduction measures have been taken when connecting the sample inlet. Pressure relief is fitted to the unit such that damage from over pressurisation is minimised but units may still be damaged.

### **3 Introduction**

The ACG+ is a multi-sensor gas analyser, specifically designed for the analysis of contaminants in compressed breathing air. The ACG+ can be used as a portable instrument for use between compressors on site or can be permanently connected to a compressor outlet, enabling you to continually verify the quality of your breathing air. This delivers a much greater degree of system safety than a 3 or 6 month spot check. The unit will provide continuous 'on line' monitoring of O<sub>2</sub>, CO<sub>2</sub>, CO, volatile organic compounds (VOC) and water vapour in compressed breathing air lines.

#### **3.1 ACG+ overview**

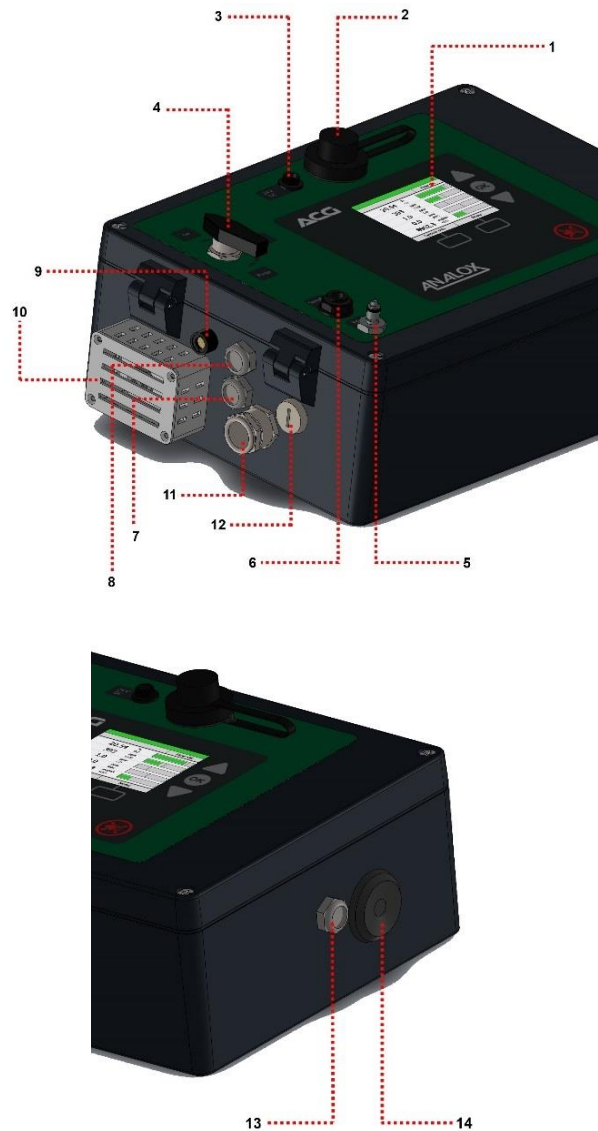

**Figure 1 ACG+ Overview**

- 1) Display
- 2) USB port for data-download, with waterproof cap
- 3) Power connection (Via either optional rechargeable battery pack or external mains adaptor)
- 4) Gas inlet/purge valve
- 5) Gas inlet/calibration port
- 6) Sample support port

- 7) Exhaust
- 8) Exhaust
- 9) Breather
- 10) Humidifier (Optional)
- 11) M16 cable gland (Optional)
- 12) Override keyswitch (Optional)
- 13) Exhaust
- 14) Blow out blanking plug

## 4 Installation details

### 4.1 Mechanical overview

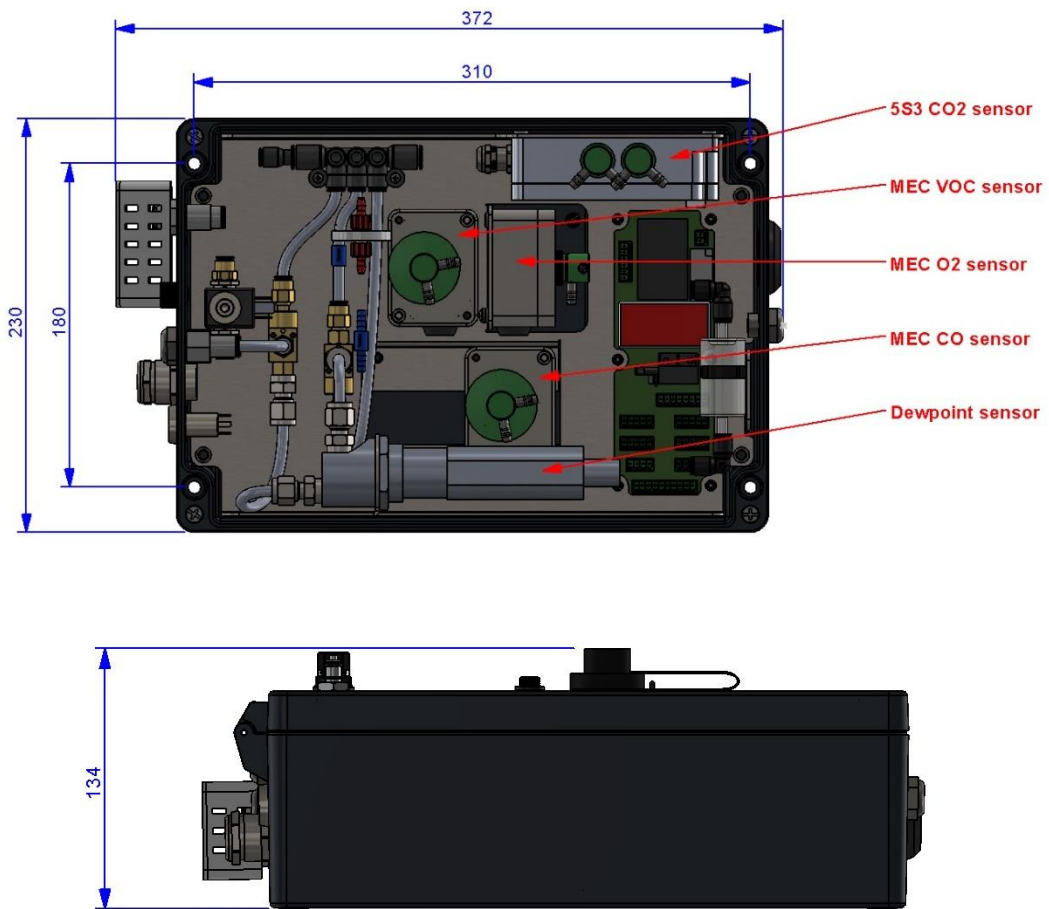

**Figure 2** ACG+ Mechanical Overview

## **4.2 Gas sample connection (Both fixed and portable versions)**

- The sample gas inlet to the ACG+ must be at a regulated pressure in the range of 5 to 10 bar gauge (72.5 to 145psig), taken directly from a sample line from a compressor, after all filtering and regulation, which is supplying the bottles, air banks or breathing masks.
- The ACG+ is supplied with a 2m length of 6mmOD x 3mmID PTFE tubing which the inlet/calibration adaptor should be connected to. Longer pipes can be used but purge times and response times will be longer.
- It is recommended that a 2-stage regulator is used to maintain the sample gas inlet pressure within operating limits.
- The ACG+ provides a Linktech panel mount coupling for the connection of the sample gas line or calibration gas and also a Linktech inline socket (Which accepts up to ¼" OD tubing) for connection to the ACG+ panel mount coupling.
- Before fitting the pipe-work the PTFE tubing should be fitted to the rear of the supplied Linktech inline socket.
- The ID at one end of the PTFE tubing will require stretching slightly to fit over the rear of the Linktech inline socket.
- Remove the nut from the rear of the Linktech inline socket and place over the supplied length of PTFE tubing.



- Fit the 6mmOD x 3mmID tubing over the end of the Linktech inline socket by slightly stretching the inner of the tube so that it fits over the rear of the adaptor and secure in place with the nut.

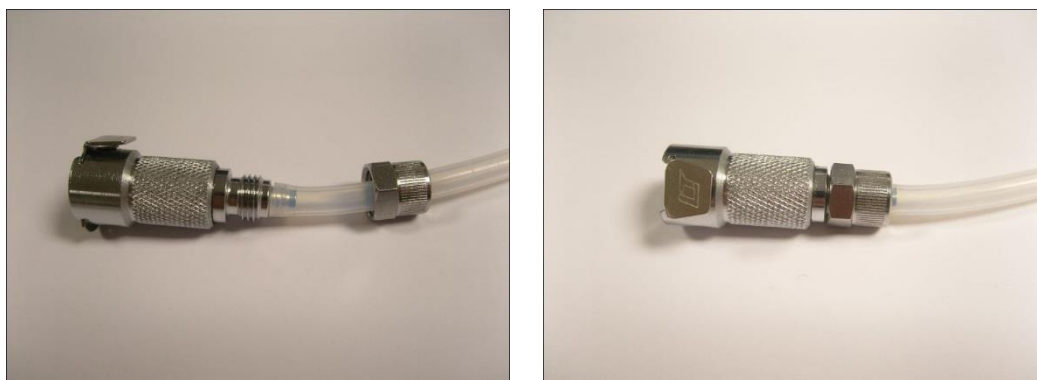

- At the free end of the PTFE tubing, a compression nut should be fitted to connect to the regulated pressure source.

### 4.3 Installation (Portable)

The ACG+ Portable can be powered by either the optional rechargeable battery pack (Li-Ion or NiMH variants) or an external PSU. Both options connect to the front panel power connector located next to the USB port.

Gas connection should be made as per section 4.2

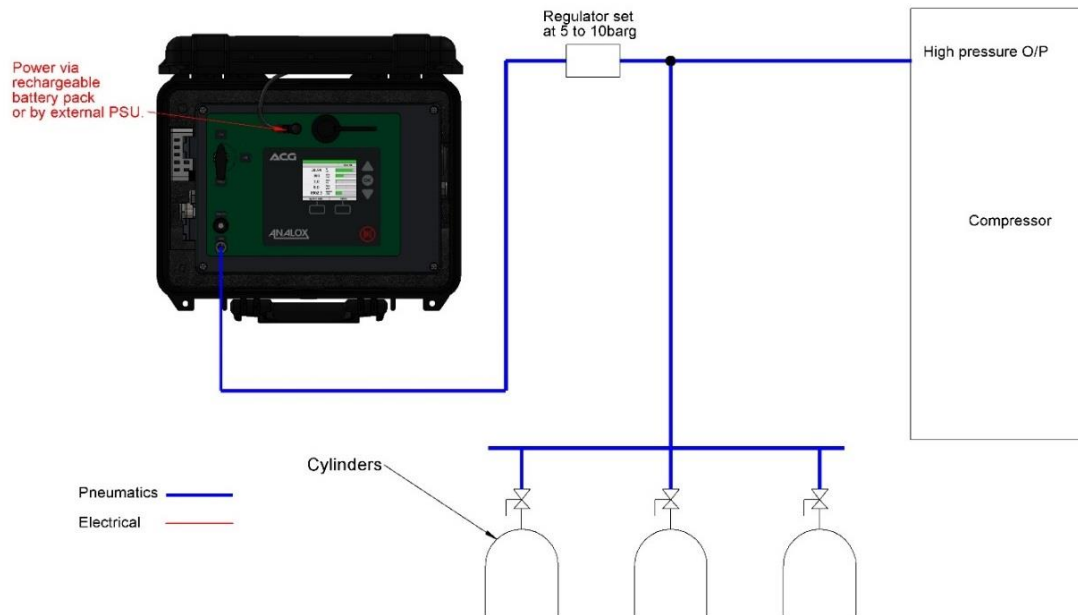

**Figure 3** Typical ACG+ Portable Installation

#### 4.3.1 ACG+ power (Portable or fixed)

Power should be applied using either the optional rechargeable battery pack or the optional external PSU. Connection should be made through the 3 way panel mount socket on the front panel located next to the USB connector.



**Battery Connection**



**Battery Connected**

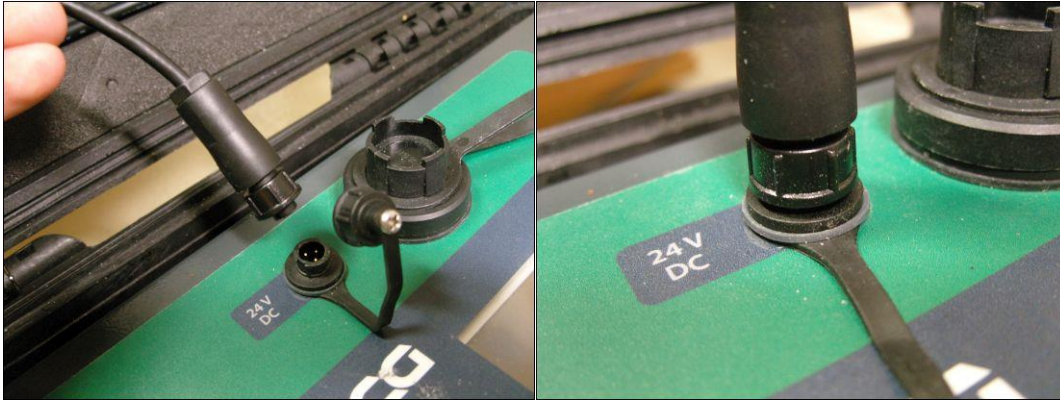

External PSU Connection

External PSU Connected

### 4.3.2 Charging the optional rechargeable battery pack

To charge the optional rechargeable battery pack the charger supplied with the battery pack kit **MUST** be used as these are set to supply the correct power to the battery during charge.



**NOTE: USING ANY OTHER CHARGER WILL INVALIDATE YOUR WARRANTY.**

- 1] Connect the charger connector to the battery connection lead coming from the battery case (This will only fit one way) and secure using the bayonet nut on the battery cable.
- 2] Plug the charger into a mains supply, the charger will do a battery check prior to charging (The charger the LED will be yellow).
- 3] If any faults are found the charger LED will flash orange/green.
- 4] If all is okay the charger will then start to charge the battery (The charger LED will be orange).
- 5] Once the charge is complete, the charger will go into trickle mode until disconnected (The charger the LED will go green).
- 6] Once complete, disconnect the charger, the battery is then ready for connection to the ACG+.



## 4.4 Installation (Fixed)

### 4.4.1 Mounting details (ACG+ Fixed)

The ACG+ can be mounted as a fixed unit onto a wall or vertical flat surface using the enclosure mounting holes. The minimum area required and the mounting centres for installing the ACG+ are shown in **Figure 2**.

Gas connection should be made as per section 4.2

Below shows a diagram of a typical fixed system setup.

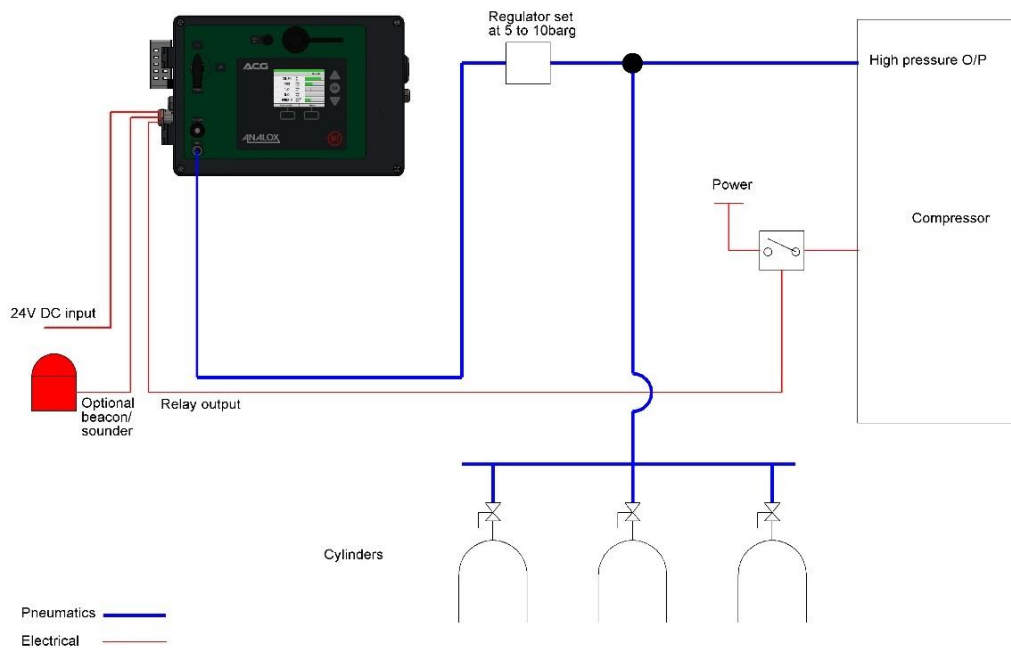

**Figure 4** Typical ACG+ Fixed installation

An optional mounting kit to install on either a solid wall or instrument panel can be purchased.

ACG+ mounting kit contents:

- 4 x Socket head cap screw, M6x60mm.
- 4 x M6 full nut, A4 SS.
- 4 x M6 washer, A4 SS.
- 4 x Multi wall fixing, M5 x 50mm (rubber insert and M5x50mm slotted screw).

### 4.4.2 Solid wall mounting (ACG+ Fixed)

- 1] Mark on the wall the mounting hole drill positions and drill 10mm holes.
- 2] Remove the M5x50mm screw from the rubber insert and fit the rubber inserts into the drilled holes.
- 3] Open the ACG+ lid and offer up the unit to the mounting surface.
- 4] Place an M5x50mm slotted screw in each of the 4 enclosure mounting positions and screw in to the previously fitted rubber inserts.

### 4.4.3 Panel mounting (ACG+ Fixed)

- 1] Mark on the panel the mounting hole drill positions and drill 6.5mm holes.
- 2] Open the ACG+ lid and offer up the unit to the mounting surface.
- 3] Place a socket head cap screw in each of the 4 enclosure mounting positions and through the drilled holes in the mounting panel.
- 4] Fit an M6 washer over each of the screw thread at the back of the mounting panel.

- 5] Fit an M6 full nut to the screw thread at the back of the mounting panel and fully tighten (alternatively, the screws could be fitted into M6 tapped holes with the M6 nuts not required).

#### 4.4.4 Electrical connection

The user terminals are located at J3 and J17 on the chassis PCB of the ACG+ as shown in Figure 5.

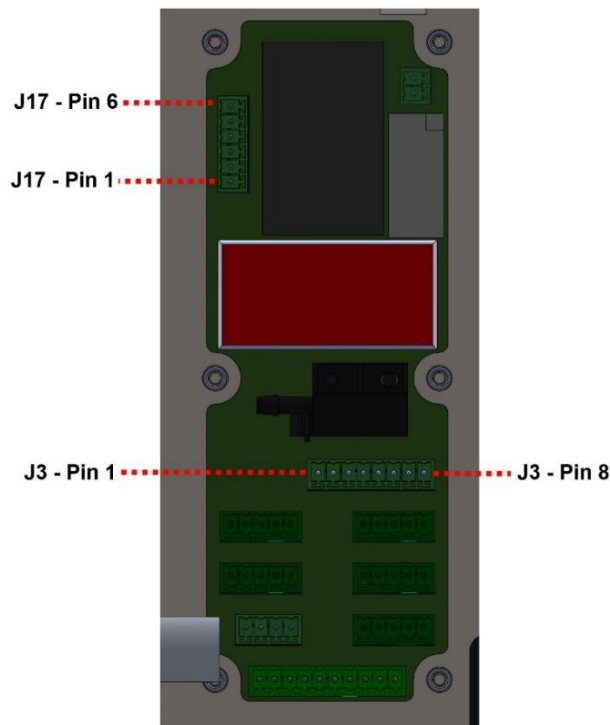

**Figure 5** Connector Locations

**Table 2** Connector J17 Pin Assignments

Connector J17 pin assignments		
Terminal No.	Function	Details
1	ACG+ power (+ve)	9 to 36V DC, 24W max
2	ACG+ power (-ve)	
3	Interlock relay contacts - normally-open (1)	Volt-free relay contacts. 8A @ 24V max. Relay contacts are normally open in power off conditions. This pair of contacts will be closed circuit under nominal conditions and open circuit in fault or alarm conditions (see section 4.5).
4	Interlock relay contacts - normally-open (2)	
5	Interlock relay contacts - normally-closed (1)	Volt-free relay contacts. 8A @ 24V max. Relay contacts are normally closed in power off conditions. This pair of contacts will be open circuit under nominal conditions and closed circuit in fault or alarm conditions (see section 4.5).
6	Interlock relay contacts - normally-closed (2)	

**Table 3 Connector J3 Pin Assignments**

Connector J3 pin assignments		
Terminal No.	Function	Details
1	Solenoid drive (+ve)	Not for user connection
2	Solenoid drive (-ve)	
3	Reserved	Not for user connection
4	Reserved	
5	+24Vdc	Max total load of 500mA is available between the 3 switched outputs
6	Output 1 - switched to 0V	
7	Output 2 - switched to 0V	
8	Output 3 - switched to 0V	



**NOTE: MAX CROSS-SECTIONAL AREA FOR THE TERMINALS IS 1.5MM<sup>2</sup>**

**4.4.5 ACG+ power (Fixed)**

The ACG+ requires a power supply of 15 to 36V DC and will consume 20 Watts maximum. It is recommended that power should be supplied using a screened, twisted pair cable, with the cable screen clamped by the EMC cable gland, this should then be terminated to J17 pins 1 & 2 as shown.

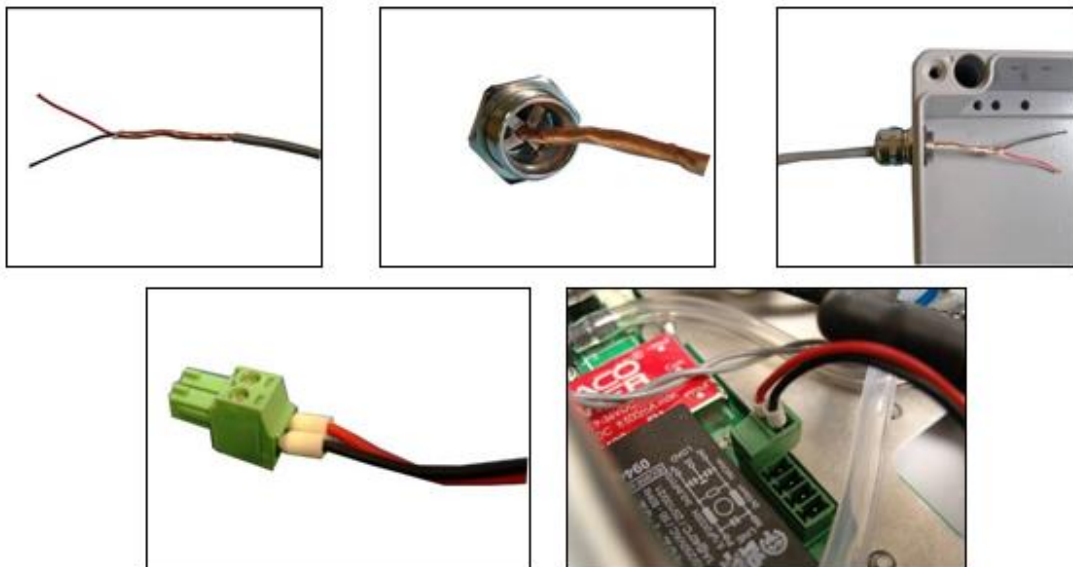

**Figure 6 ACG+ Power**

**4.5 Safety interlock relay (ACG+ Fixed)**

The ACG+ has a double pole change-over relay that can be used to control external equipment in the event of an alarm or fault condition.

Two sets of volt-free relay contacts are provided; a normally-open pair which are held closed under ideal conditions, failing safe to their open state when a non-ideal state is identified and a normally-closed pair which are held open under ideal conditions. Figure 6 shows the operational state of the relay under various system conditions.

A typical use of the interlock relay might be to use the normally-open pair to cut power to a compressor or to close a filling valve on an alarm, fault condition, or in the case of power loss. Alternatively, the normally-closed pair can be used to activate external, self-powered alarm equipment such as a beacon.

**Figure 7** shows a typical example of the relay used in a system

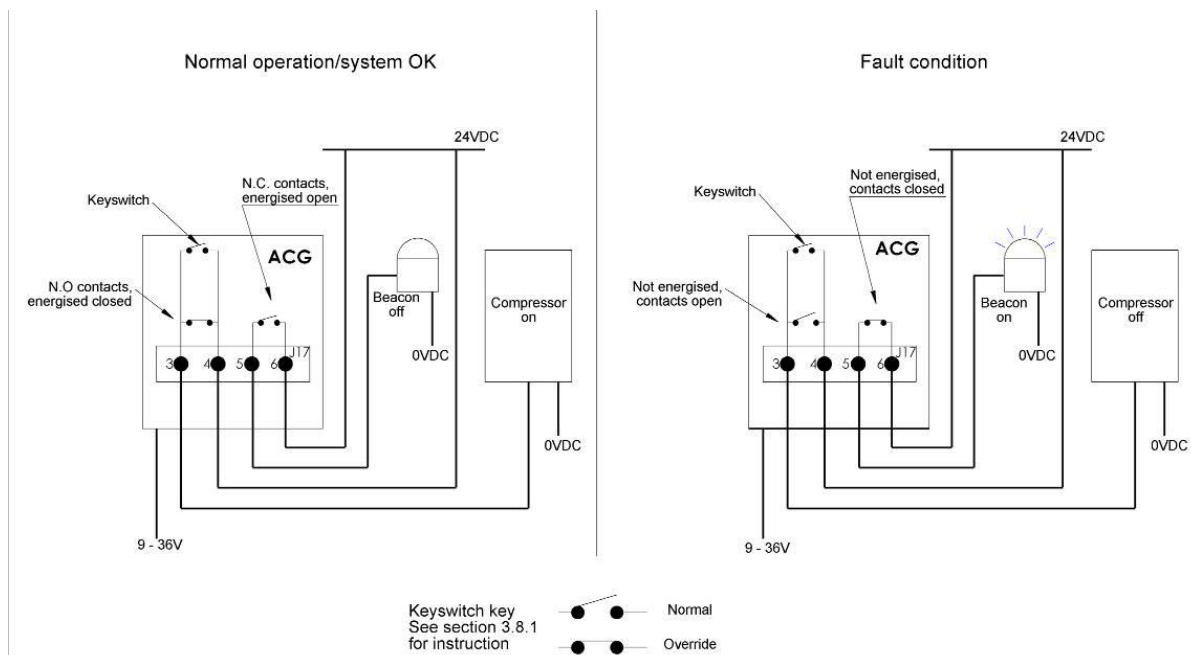

**Figure 7**      **Typical Interlock Relay Wiring**

### 4.6 Safety interlock override key-switch (ACG+ Fixed)

If an ACG+'s safety interlock relay (If fitted) is attached to external equipment, there may be circumstances where it is not desirable for the ACG+ to disable the equipment attached under alarm or fault conditions. The ACG+ provides an optional override key-switch, mounted on the left side of the unit. With the key-switch set to 'Normal', the external equipment will be switched in the event of an alarm or fault conditions. If the key-switch is set to the 'Override' position then the external equipment will not be affected by alarm and fault conditions. Table 4 shows how the key-switch affects the various system outputs.



**NOTE: THE SAFETY INTERLOCK OVERRIDE KEY-SWITCH ONLY APPLIES TO EQUIPMENT CONNECTED TO THE NORMALLY-OPEN PAIR OF CONTACTS (J17, PINS 3 & 4).**

**Table 4 Relay and 24V Output Operation under Fault and Alarm Conditions**

System condition	Key-switch state	Interlock relay (normally-open pair)	Interlock relay (normally-closed pair)	Switched 24V output 1	Switched 24V output 2	Switched 24V output 3
ACG+ power off	Normal	Open circuit	Closed circuit	Off	Off	Off
	Override	Closed circuit				
Ideal conditions (no alarm or fault)	Normal or override	Closed circuit	Open circuit	Off	Off	Off
Inlet alarm only (flow or inlet pressure alarm)	Normal or override	Closed circuit	Open circuit	On	On	On
Sensor alarm active	Normal	Open circuit	Closed circuit	On	On	On
	Override	Closed circuit				
System or sensor fault active	Normal	Open circuit	Closed circuit	On	On	On
	Override	Closed circuit				

### 4.7 Switched 24V DC outputs (ACG+ Fixed)

The ACG+ has 3 switched 24Vdc outputs that provide power to external equipment in the event of an alarm condition or system fault. These can be used to power directly equipment such as, for example, a beacon, an audible alarm, or to energise a relay. They can also be used as an input signal to an external control system. Table 4 shows how the switched 24V outputs operate under various system conditions.

**Figure 8** shows a typical example of the switched 24V DC outputs used in a system.

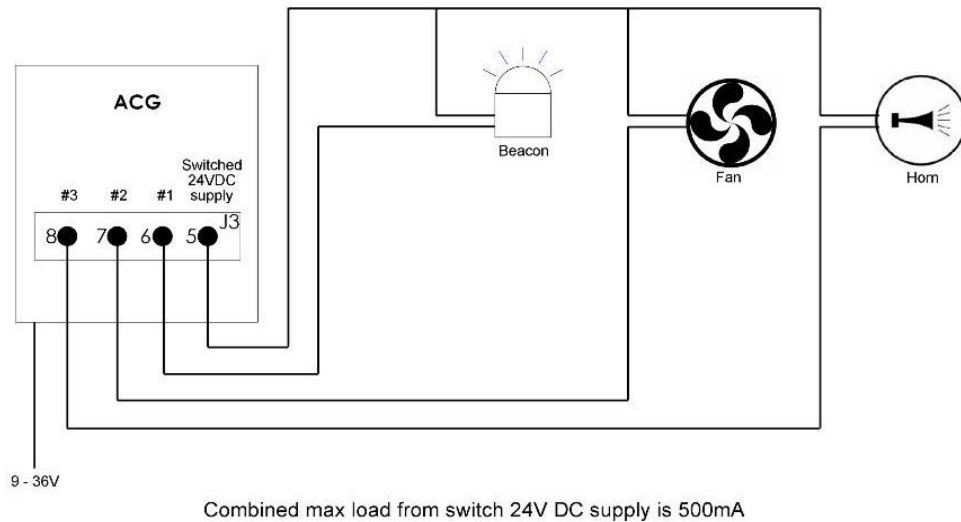

**Figure 8** Typical Use of Switched 24V Outputs

## 5 Operating instructions

### 5.1 Start-up

An ACG+ will automatically start up when power is supplied to it. Initially, the ACG+ will display a splash screen as shown in **Figure 9** which will be displayed for a few seconds after which the display will go blank for up to 15 seconds. The ACG+ will then show the main display as described in section 5.4.1

Upon start-up, attached sensors may require a short time to warm up as described in section 5.9.3

The ambient pressure limit is 800 to 1100 mbar.



**NOTE: FOR THE CO SENSOR TO ACHIEVE THE ACCURACY SPECIFIED, A WARM UP PERIOD OF 30 MINUTES IS ADVISED PRIOR TO CARRYING OUT CALIBRATION ADJUSTMENTS OF THE ACG+ SENSORS.**

Also, to achieve the accuracy specified, a warm up period of 15 minutes is advised prior to recording the ACG+ sensors displayed values.



**NOTE: THE ACG+ CO SENSOR REQUIRES A REPRESENTATIVE O2 LEVEL IN BOTH THE ZERO AND SPAN CALIBRATION GASES (SEE ZERO AND SPAN GAS VALUES IN THE ACCESSORIES SECTION).**



**NOTE: IF ANY EQUIPMENT USED WITH THE ACG+ IS CONNECTED INTO THE SAFETY INTERLOCK RELAY (SECTION 4.5), THEN DEPENDING ON THE CONNECTION SCHEME, IT MAY BE NECESSARY TO SWITCH THE SAFETY INTERLOCK KEY-SWITCH TO THE OVERRIDE POSITION DURING START-UP AND UNTIL THE SENSORS HAVE STABILISED ON A STEADY GAS FLOW. THIS PREVENTS ANY DISRUPTION TO ATTACHED EQUIPMENT DURING START-UP DUE TO ANY ALARMS (FOR EXAMPLE, A HIGH ALARM DUE TO ATMOSPHERIC AIR PRESENT IN INTERNAL PLUMBING).**

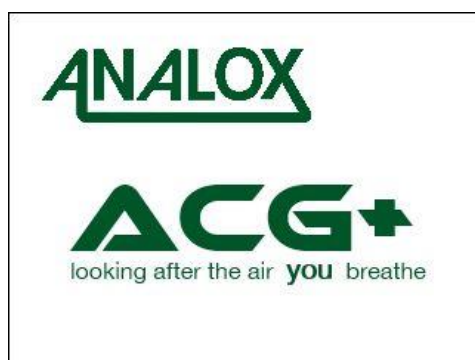

**Figure 9 Start-Up Splash Screen**

## 5.2 Controls

Figure 10 shows the elements of the ACG+ front panel.

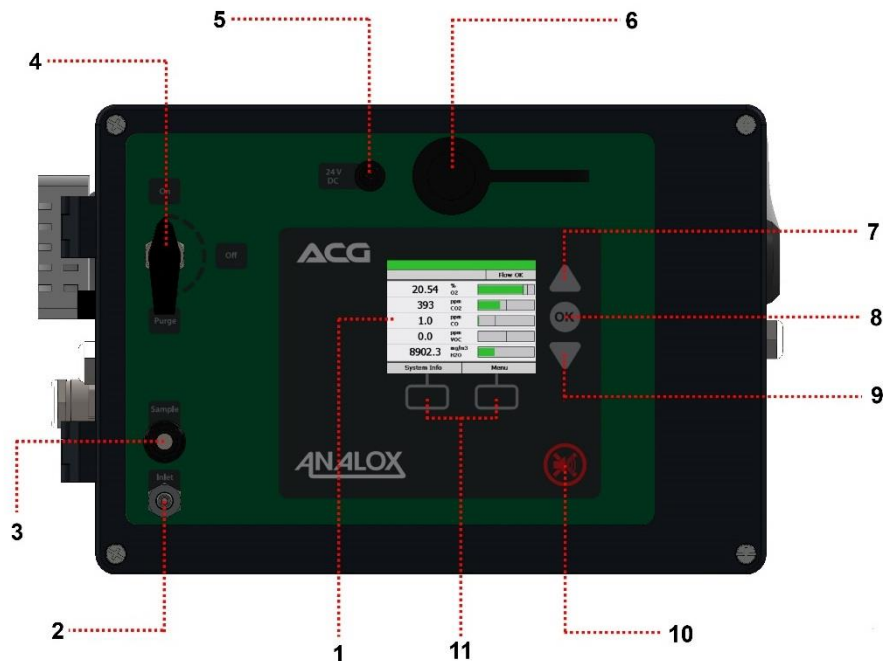

**Figure 10** ACG+ Front Panel

- 1) Display
- 2) Sample/Calibration gas inlet
- 3) Gas outlet for timed sample support (section 5.17)
- 4) Gas inlet/purge valve
- 5) External power connection (Either by rechargeable battery pack or external PSU)
- 6) USB port
- 7) Up button
- 8) OK button
- 9) Down button
- 10) Mute button
- 11) Context sensitive buttons (function depends on current context)



## **5.3 Inlet/purge valve**

### **5.3.1 Use of the inlet/purge valve**

The inlet/purge valve is used to control the flow of gas into the ACG+. It has two functions, firstly to turn the flow of gas through the sensors on and off, and secondly to vent the inlet, to purge any stale gas in the line.

Analox recommend that the purge system is used whenever a new pipe connection is made to the ACG+, if the inlet line has been open to atmosphere or it has been exposed to damp gas. The following instructions apply when using the supplied 2m PTFE pipe. If shorter or longer lengths of pipework are used, the purge period should be adjusted accordingly, depending on the total pipe length. Only stainless steel or PTFE/FEP pipework should be used to connect to the ACG+.

Starting with the valve in the "off" position, apply pressure to the inlet (Between 5 and 10 bar gauge) using the supplied Linktech inlet/calibration connector.

Once pressure is applied, the valve should be turned to "Purge" and left for 2 minutes (Using the supplied 2m PTFE pipe) so that the pipework prior to the ACG+ can be purged of any stale, damp gas, and any moisture on the pipe walls can be dried out.

Once the purge has completed, the valve can then be turned to the "On" position to allow the sensors to start analysing the gas sample. This process will ensure the ACG+ sensors can stabilise as quickly as possible to the gas you wish to measure.

## 5.4 Display

### 5.4.1 Main display screen

Under normal operation the ACG+ will display its main display screen. **Figure 11** explains the elements of the main screen.

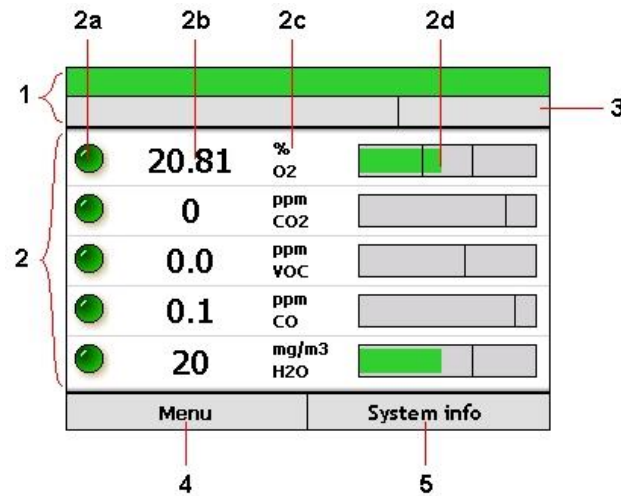
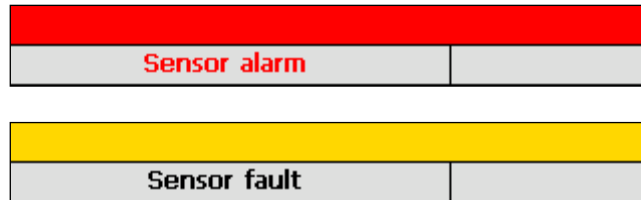

**Figure 11** Main Display Overview

1. System status indicator
2. Live sensor readings
  - a. Sensor status icon
  - b. Sensor reading
  - c. Sensor type and display units
  - d. Sensor bar indicator
3. System information bar
4. Left context menu button (used to access menu in the case shown)
5. Right context menu button (used to access the system information page in the case shown).

### 5.4.2 System status indicator

The system status indicator shows the current status of the ACG+ system. If any alarm condition has been identified then the system status indicator will turn red and display the word 'Alarm'. If any system fault is identified then the status indicator will turn yellow and display the word 'Fault'. If no current alarm or fault conditions have been identified then the system status indicator will turn green. **Figure 12** shows examples of system status indicator states.

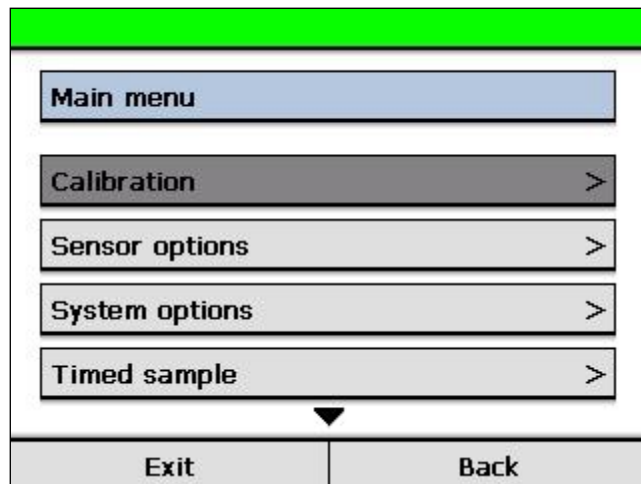

**Figure 12** System Status Indicator

The system indicator also shows system diagnostic information regarding system parameters of flow and input pressure. If an operational parameter is out of specification, it shall be indicated in the system parameters information box. See troubleshooting (section 8) for explanation of system fault codes.

## 5.5 Menu

The device main menu can be accessed from the main screen by pressing the left context button (Figure 13).



**Figure 13** The Main Menu

The highlighted menu option can be changed by using the up and down buttons. An arrow at the top or bottom of a menu indicates that there are more menu options above or below those currently shown.

To select a menu item, highlight it and press the 'OK' button. Depending on the menu item selected, the selected action will be performed or a sub-menu will be displayed. **Figure 14** shows the backlight sub-menu.

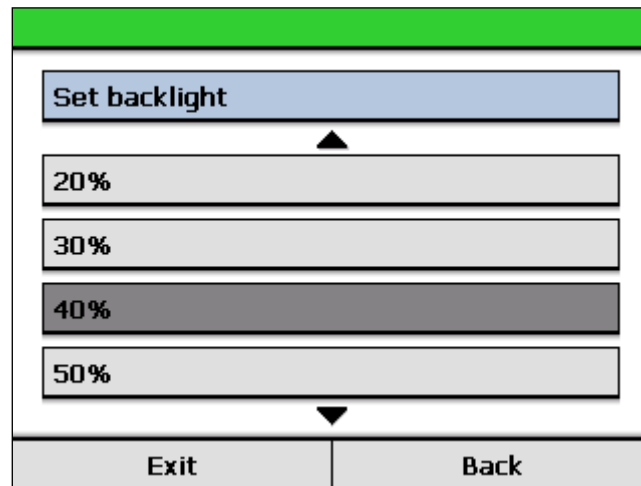

**Figure 14**     *The Backlight Sub-Menu*

Selecting the back option from a sub-menu will return to the previous menu level. The exit context button can be pressed at any time whilst using the menu to return to the main screen.

### **5.6**     **Adjusting the backlight**

The brightness of the ACG+ display can be changed to suit the lighting conditions of its location by adjusting the backlight intensity. To adjust the backlight level, enter the main menu and select 'System options>Backlight'. Next select the desired backlight intensity level (10 to 100%) from the menu.



**NOTE:**     **DUE TO THE NATURE OF THE DISPLAY TECHNOLOGY, THE MAXIMUM INTENSITY OF THE DISPLAY WILL SLIGHTLY DEGRADE OVER THE LIFESPAN OF THE PRODUCT. FOR NEW SYSTEMS IT IS RECOMMENDED THAT THE BACKLIGHT IS SET TO AN INITIAL INTENSITY LEVEL OF 60% OR LESS TO MAXIMISE THE LIFESPAN OF THE DISPLAY**

### 5.7 Power sub-menu

You are able to reset & put the system into sleep mode via the device's 'Power' menu. When the reset option is selected the device performs a soft reset reloading all configurations.

When the device is in sleep mode this disables the following:

- Networking capabilities
- Sounder
- Data logging
- Alarms
- Screen

To exit sleep mode you simply press 'OK' once, exiting sleep mode shall re-enable all of the above sleep conditions.

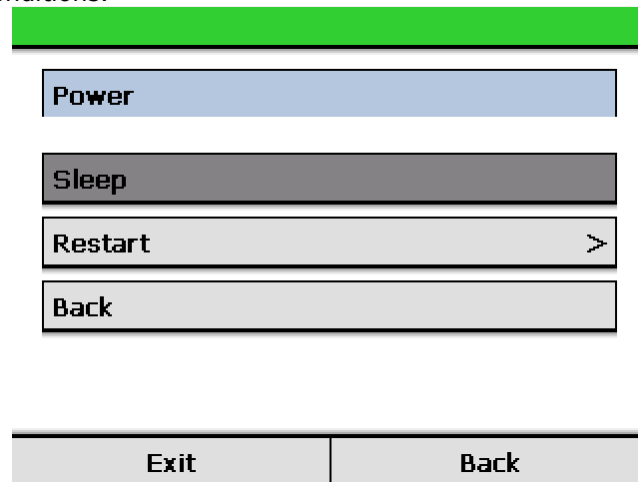

**Figure 15** Power Sub-Menu

### 5.8 System flow

For accurate analysis of a gas sample, a reasonable flow must be maintained to the ACG+'s sensors. The internal flow is automatically regulated by the ACG+ provided that an appropriate sample inlet pressure is provided (see section 11.1 for inlet pressure ratings). The ACG+ constantly monitors its internal flow. If the parameters are outside of its nominal range, a warning alarm will be triggered and the horn will be sounded.

In addition, when an unsuitable flow rate is measured, all sensor values will be marked as uncertain (grey icon) along with a flashing indication that the flow rate is currently invalid.

The measured flow rate can be viewed on the system information screen as described in section 5.13.



**NOTE: ALARMS TRIGGERED BY FLOW DO NOT AFFECT THE CURRENT STATE OF THE SAFETY INTERLOCK RELAY (FIXED VARIANTS) (SEE SECTION 4.5).**

## 5.9 Sensor readings







### 5.9.1 Sensor reading update

A live reading from each sensor will be displayed in a sensor window on the main display. This reading will be updated on the display once per second. If no valid sensor reading is currently available then three dashes ('---') will be shown instead. This may occur if the sensor has identified a fault in its operation or on occasions where the sensor reading is unavailable due to routine processing such as after a calibration adjustment has been performed.

### 5.9.2 Sensor status

The sensor status icon is shown to the left of each sensor reading. This icon indicates the current status of the sensor. The meaning of each sensor icon is explained in **Table 5** below.

**Table 5** *Sensor Status Icons*

Icon	Meaning
 GREEN	<b>OK.</b> The sensor is returning a value which is within alarm limits.
 RED	<b>Alarm.</b> The sensor is returning a value which is outside of an alarm set-point. This icon will flash when a new alarm condition is identified and until the alarm is acknowledged by pressing the mute button. See section 5.10 for more on alarms.
 GREY	<b>Uncertain.</b> This icon is shown when the sensor is returning a reading which is within alarm limits but the reading cannot be guaranteed correct, for example, when there is low gas flow through the system. This icon will be accompanied by a status code. See troubleshooting section for further information on the specific condition.
	<b>Fault.</b> This icon indicates that a fault has been identified with the sensor. This icon will be accompanied by a status code. See troubleshooting section for further information on the specific condition. This icon will flash when a new fault condition is identified and until the fault is acknowledged by pressing the mute button.
	<b>Processing.</b> This animated icon indicates that the digital sensor module is performing some internal function. This icon will be shown when the sensor is in warm-up or has been re-connected (section 5.9.3)
	<b>Calibration due.</b> This flashing icon is intended as a reminder that the sensor should have a calibration adjustment performed (section 5.12.4).
	<b>Replacement due.</b> This flashing icon is intended as a reminder that the sensor or element of the sensor should be replaced (section 5.16).

### 5.9.3 Sensor warm-up

Under certain circumstances, when a digital sensor attached to the ACG+ cannot display a valid reading, the display will show that the sensor is in a warm-up state. Warm-up occurs when the ACG+ is initially powered up and may last 10 to 60 seconds depending on the sensor type attached. Under certain circumstances the sensor may enter a warm-up state whilst it processes information such as after a calibration adjustment has been attempted or when a sensor is re-connected after being disconnected. Whilst in a warm-up state, the display reading for the sensor is shown as three dashes ('---') and a warm-up processing animation is displayed (**Figure 16**).

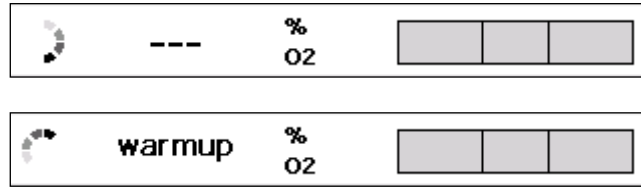

**Figure 16** Example of a Sensor that is in a Warm-Up State

### 5.9.4 Sensor bar graph indicator

The sensor bar graph indicator is used to display information regarding the current sensor reading and its associated alarms. The sensor bars are automatically scaled to best show the current sensor with respect to its alarm set-points. The left hand edge of the bar is not necessarily representative of zero. For sensors such as oxygen where there is both a low-going and a high going alarm, this allows the region around the alarm set-points to be shown more clearly. The bar graph is not intended to show absolute readings.

For sensors where only a single high-going alarm set-point is defined, such as carbon dioxide, the bar will be scaled from zero to an amount above the high-going set-point. This allows any rising carbon dioxide levels to be seen with respect to the alarm set-point.

The bar will change colour depending on the current sensor status. Where a sensor is in a non-alarm and non-fault state, the bar graph will be shown green as shown in **Figure 17.a** below. Should the sensor value be in an alarm state, the bar will be shown in red, as per **Figure 17.b** and **Figure 17.c** which show a low and high alarm respectively.



**Figure 17** Sensor Bar Graph Indicator

In circumstances where a reading is available but is in a degraded state (e.g. a timely calibration has not been performed), the sensor bar graph indicator will be shown grey as shown in **Figure 18.a** below. Should no reading be available, the bar graph will show no reading as shown in **Figure 18.b** below.

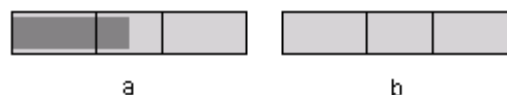

**Figure 18** Degraded State Sensor Bar Graph Indicator

In cases where the reading falls outside of the displayed range of the bar graph, the bar graph indicator will show a directional arrow to indicate the reading is outside of the displayed region as shown in **Figure 19** below.

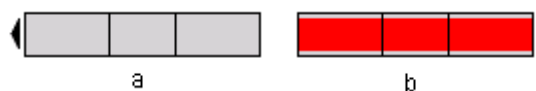

**Figure 19** Out Of Display Range Bar Graph Indicators

In cases where a sensor fault has been identified and a reading can still be obtained from the sensor, the bar graph will be shown coloured yellow (**Figure 20**).



Figure 20 Sensor in Fault Bar Graph Indicator

## 5.10 Alarms

Every second, as the sensor reading is updated, each alarm associated with the sensor is checked against the current reading. For high-going direction alarms, an alarm condition will be triggered if the sensor reading is greater than the alarm set-point. Conversely, for low-going direction alarms, an alarm condition will be triggered if the sensor reading is less than the alarm set-point.

Sensor alarm			
	18.81	% O2	
	0	ppm CO2	
	0.0	ppm VOC	
	0.1	ppm CO	
	20	mg/m3 H2O	
Menu			

Figure 21 A Low-Going Alarm That Has Been Triggered

When an alarm condition is identified the horn will immediately sound and the system status indicator will turn red, showing the word 'alarm'. In addition the sensor reading will be displayed with a flashing red status indicator and the reading bar graph will turn red, showing the reading outside of the alarm threshold. **Figure 21** shows an example of a low-going alarm that has been triggered by a low oxygen reading.

### 5.10.1 Muting alarms

When an alarm condition is triggered and the horn sounds, the horn can be muted by pressing the mute button. This will mute the horn on all occasions where the horn is activated. In addition, when an alarm is muted, the sensor status indicator on the display will stop flashing and will instead be shown in solid red to indicate that the alarm has been acknowledged.



Figure 22 Mute Button



**5.11 Clearing alarms and hysteresis**

To avoid nuisance re-triggering of alarms when a sensor reading is fluctuating around an alarm set-point, each alarm has a hysteresis band applied to it. This hysteresis applies to the clearing of an already triggered alarm. An alarm will always trigger immediately when the sensor reading passes the set-point in the correct direction. However, when the sensor returns in the opposite direction through the same set-point, it must go an amount beyond the set-point before the alarm will clear. This extra amount required to clear an alarm is the alarm’s hysteresis. **Figure 23** shows an example of a hysteresis band on a high going alarm.

The hysteresis applied to an alarm is adjusted automatically based on the value of the alarm set-point. Hysteresis for each sensor range is defined by a percentage of set-point and a maximum hysteresis value. The hysteresis applied to the alarm is the smaller of the two values for a particular set-point. **Table 6** shows the hysteresis applied to each sensor type.

**Table 6 Scaled Hysteresis Values**

Sensor	Percent of set-point hysteresis	Maximum hysteresis
% O <sub>2</sub>	5%	0.5% O <sub>2</sub>
ppm CO <sub>2</sub>	5%	50ppm CO <sub>2</sub>
ppm CO	5%	0.5ppm CO
ppm VOC	5%	0.5ppm VOC
mg/m <sup>3</sup> H <sub>2</sub> O	5%	5mg/m <sup>3</sup> H <sub>2</sub> O

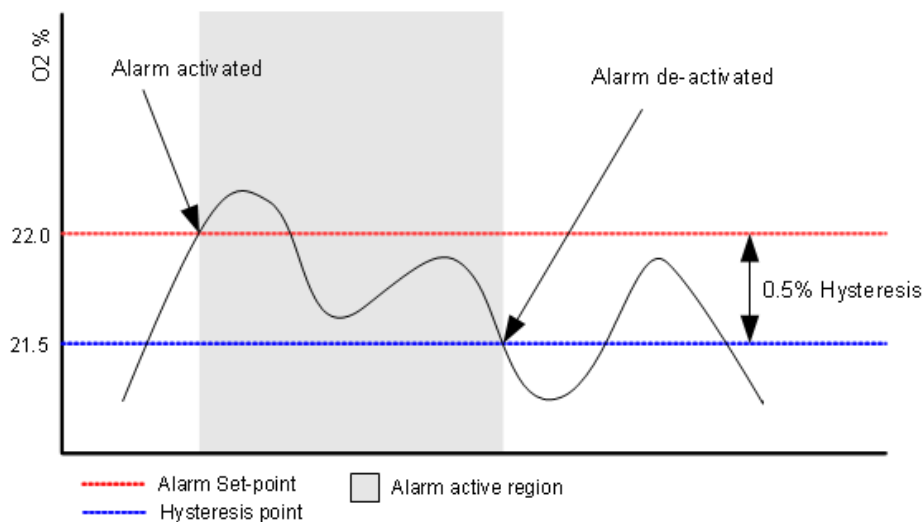

**Figure 23 Hysteresis Band on a High Going Oxygen Alarm**

### **5.11.1 Latching alarms**

Alarms can operate in either latching or non-latching mode.

With latching alarms **disabled**, if an alarm is triggered and the sensor reading subsequently returns to a level that would not trigger the alarm, the visual and audio indicators will be cancelled as soon as the reading passes the hysteresis point (see section 5.4.2)

With latching alarms **enabled**, if an alarm is triggered and the sensor reading subsequently returns to a level that would not trigger the alarm, the visual and audio indicators will continue until the mute button is pressed to acknowledge the alarm. Once acknowledged, the visual and audio indicators will be cancelled. Whilst latching is **enabled**, if an alarm is acknowledged by pressing the mute button prior to the sensor reading passing back through the alarm set-point then the visual and audio indicators will be cancelled as soon as the reading passes the hysteresis point (see section 5.4.2). The alarm latching option can be turned on and off through the device menu. This can be found in the main menu under 'System options>Alarm latching'. The latching alarm option can also be changed using the PC tool (see section 6.3).

### 5.11.2 Adjusting alarm set-points

Each of the ACG+'s alarm set-points can be individually adjusted to suit the monitoring application. To adjust a set-point, first select the alarm using the 'Sensor options' sub-menu from the main menu (**Figure 24**). Select the sensor of interest and select 'Adjust alarms'. A list of the available alarms will be shown in the next menu. Select which alarm to adjust and the alarm adjustment screen will be shown.

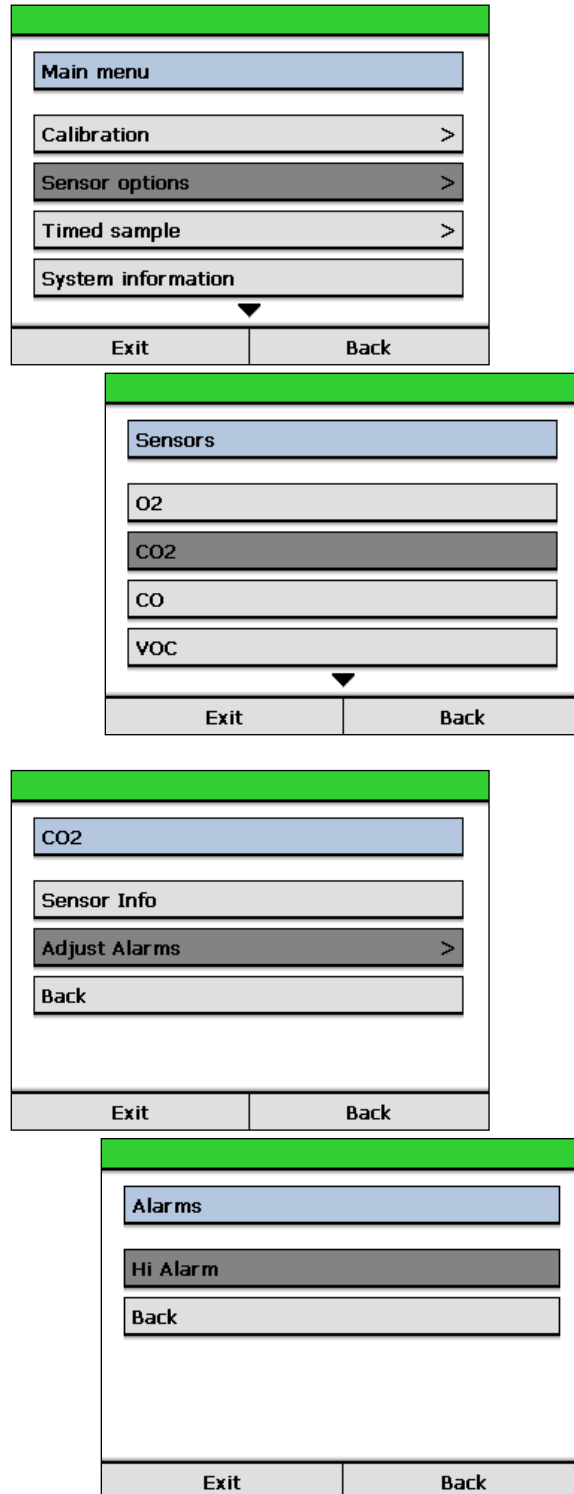
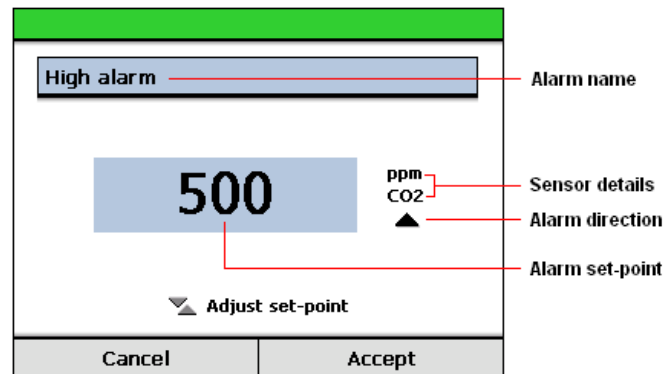

Figure 24 Selecting a CO<sub>2</sub> Alarm to Adjust

Using the up and down adjustment keys, adjust the alarm set-point to the required value (**Figure 25**). Once the desired new set-point is shown, press 'Accept' to store the new value. Press 'Cancel' to leave the alarm set-point unchanged.



**Figure 25** Example of Alarm Set-Point Adjustment

## 5.12 Calibration adjustment

Whilst in use, an ACG+'s sensors should be periodically calibrated at intervals deemed necessary for the monitoring application, by exposing the sensor to gas of a known concentration. Due to effects such as depletion of electro-chemical cells over time, sensor readings shown when they are exposed to a gas of known concentration may differ from the expected value. To compensate for these effects, calibration adjustments of the sensors can be made where necessary as follows.

Each sensor's output is defined by two calibration points, one low and one high. To perform a successful calibration adjustment, both low and high calibration points should be adjusted.



**NOTE: THE HIGH AND LOW CALIBRATIONS PERFORMED ON A SENSOR SHOULD BE SELECTED APPROPRIATELY. SOME SENSORS (E.G. CARBON DIOXIDE) REQUIRE THAT THE LOW CALIBRATION IS A TRUE ZERO CALIBRATION ADJUSTMENT. FOR THESE SENSORS, A GAS WITH A KNOWN ZERO CONCENTRATION OF THE TARGET GAS SHOULD BE USED. FOR OTHER SENSORS WHERE THE LOW CALIBRATION ADJUSTMENT IS NOT RESTRICTED, A HIGH AND LOW CALIBRATION ADJUSTMENT VALUE SHOULD BE SELECTED. THE SELECTED GAS CONCENTRATIONS SHOULD BEST REFLECT THE RANGE OVER WHICH THE SENSOR IS INTENDED TO BE USED FOR GREATER READING ACCURACY.**

For calibration of standard ACG+ sensor parts, the following gas mixes are recommended. Factory configurations for each ACG+ contain the calibration information for these gas mixes which can be used for ease of repeat calibration. These values can be modified if alternative mixes are used.

**Table 7 Recommended Calibration Gas Concentrations**

Sensor	Recommended low calibration concentration	Recommended high calibration concentration
O <sub>2</sub>	0 to 10% O <sub>2</sub>	20 to 25% O <sub>2</sub>
CO <sub>2</sub> (0 to 1000ppm range)	0ppm CO <sub>2</sub>	800 to 1000ppm CO <sub>2</sub>
CO <sub>2</sub> (0 to 10000ppm range)	0ppm CO <sub>2</sub>	8000 to 10000ppm CO <sub>2</sub>
VOC	0ppm VOC	15 to 20ppm isobutylene (C <sub>4</sub> H <sub>8</sub> )
CO	0ppm CO*	15 to 20ppm CO*
H <sub>2</sub> O	Not for user calibration	Not for user calibration

\*When performing a calibration of carbon monoxide (CO), due to the nature of the CO cell chemistry, a balance of air (20.9% oxygen) should be present in the calibration gas mix in order to ensure maximum sensor accuracy.

### 5.12.1 Performing an adjustment



**WARNING:** BEFORE A CALIBRATION GAS IS APPLIED TO THE ACG+, ENSURE THAT THE SAMPLE GAS HAS BEEN ISOLATED AND SAMPLE/CALIBRATION ADAPTOR HAS BEEN REMOVED FROM THE ACG+ INLET.



**CALIBRATION GAS FLOW SHOULD BE SET AT 0.5L/M. THIS IS BEST ACHIEVED BY USING THE GAS FLOW REGULATOR ACCESSORY (SEE SECTION 9) WHICH IS PRE-SET AT 0.5L/M.**



**NOTE:** FOR BEST RESULTS, THE ACG+ SENSORS SHOULD BE CALIBRATED WITH THE LOW CALIBRATION MIX FIRST, FOLLOWED BY THE HIGH CALIBRATION MIX.



**NOTE:** WHILST THE ACG+ IS EXPOSED TO CALIBRATION GAS, ALARMS MAY BE TRIGGERED. SET THE SAFETY INTERLOCK KEY-SWITCH (IF FITTED ON FIXED VERSION) TO OVERRIDE IF ALARMS ARE LIKELY TO CAUSE UNWANTED DISRUPTIONS TO ATTACHED EQUIPMENT.

To perform a calibration adjustment, first expose the sensors to the appropriate calibration gas of known concentration via the sample/calibration gas inlet as follows:

- 1] Fit the 0.5 LPM gas flow regulator accessory (see section 9) or suitable regulator to the calibration gas bottle (Figure 26).



**Figure 26** *Flow Regulator Fitted to Calibration Bottle*

- 2] Connect the outlet of the regulator to the inlet/calibration gas connector accessory (see section 9) and then connect the inlet/calibration gas connector to the calibration inlet on the ACG+ (Figure 27). Push the fitting on fully until it latches in place.

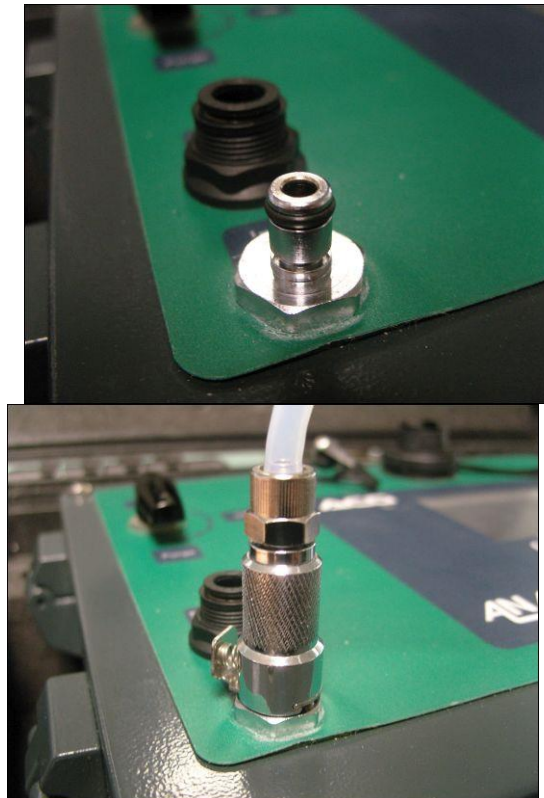

**Figure 27** *Connecting Calibration Fitting to ACG+ Calibration Port*

- 3] Open the valve on the flow regulator attached to the bottle and then open the inlet valve on the front panel. The ACG+ should register that there is flow to the sensors.



- 4] Allow 10 minutes for the sensors to settle to stable readings on the calibration gas.
- 5] To perform an adjustment, from the main menu select 'Calibration' then select the bottle that is currently attached. The calibration adjustment screen will be shown (Figure 28).





OK Edit				
		Cal?	Conc.	Hi/Lo
% O <sub>2</sub>	20.89	<input checked="" type="checkbox"/>	20.90	Hi
ppm CO <sub>2</sub>	877	<input checked="" type="checkbox"/>	900	Hi
ppm VOC	18.2	<input checked="" type="checkbox"/>	18.0	Hi
ppm CO	17.8	<input checked="" type="checkbox"/>	18.0	Hi
Exit		Begin calibration		

**Figure 28 Calibration Adjustment Screen Showing High Calibration Bottle**

- The values on the left show the current sensor readings. (Note that it is possible for sensors to show negative readings when exposed to zero gas in this situation. This is likely when attempting to measure values close to zero).
- The calibration bottle details are shown on the right. (If the values shown are not correct for the bottle attached, the values can be changed. See section 5.12.3).
- The calibration details also show the type of calibration (low or high) which will be performed for the selected bottle.
- Calibration details will not be shown for all sensors. Certain sensors that cannot be user adjusted are excluded such as the H<sub>2</sub>O sensor.
- If not all sensors shown are to be adjusted, sensors can be excluded from the adjustment (see section 5.12.2).



- 6] To begin a calibration adjustment, press the 'Begin calibration' context button.**
- For each sensor marked for adjustment, a rotating progress symbol will be shown whilst each sensor works out whether the adjustment is valid.
  - After a short delay the result of the adjustment will be shown (**Figure 29**). If the adjustment was successful, a green icon will be shown. If the adjustment was not successful, a red icon will be shown. For troubleshooting of failed adjustments see section 8.1.3

OK	Edit		Cal?	Conc.	Hi/Lo
%	O <sub>2</sub>	warmup		20.90	Hi
ppm	CO <sub>2</sub>	warmup		900	Hi
ppm	VOC	warmup		18.0	Hi
ppm	CO	warmup		18.0	Hi
Exit			Begin calibration		

**Figure 29 Calibration Adjustment Results - CO<sub>2</sub> Sensor Failed to Adjust**

- After any calibration adjustment request is processed, the sensors may enter a warm-up state for a few seconds during which time the sensor reading will not be available.
- 7] Allow the sensors 1 minute to stabilise after calibration and check that the readings shown are reasonable for the calibration gas applied.**
- 8] To finish, close the valve on the bottle flow regulator and close the inlet valve on the front panel then disconnect the calibration connector from the ACG+ by pressing the release catch and gently removing.**



- 9] Repeat for a high calibration as necessary. (Note that both low and high calibration adjustment should be performed in order to reset calibration due notifications).**

### 5.12.2 Excluding sensors from calibration adjustment

When performing an adjustment, individual sensors may be excluded so that only certain sensors are adjusted.

- 1] To exclude sensors press 'OK' whilst the calibration screen is shown to allow sensor selection. Use the up and down buttons to select a sensor to exclude.
- 2] To exclude the highlighted sensor, press the 'Enable/Disable' context button. The excluded sensor will be unchecked and greyed out (Figure 30).
- 3] To re-enable the sensor for adjustment, press the 'Enable/Disable' context button again. This can be repeated for multiple sensors.
- 4] To exit editing mode so that the adjustment can be performed, press the 'Exit Edit' context button.

OK Edit	Sensor	Cal?	Conc.	Hi/Lo
% O <sub>2</sub>	20.89	<input checked="" type="checkbox"/>	20.90	Hi
ppm CO <sub>2</sub>	877	<input checked="" type="checkbox"/>	900	Hi
ppm VOC	18.2	<input type="checkbox"/>	18.0	Hi
ppm CO	17.8	<input checked="" type="checkbox"/>	18.0	Hi
Exit Edit		Enable/Disable		

Figure 30 Excluding the VOC Sensor from the Calibration Adjustment

### 5.12.3 Editing calibration bottle values

By default, the ACG+ has two calibration bottles defined. If you are using a calibration bottle which has values which are slightly different from the bottle values defined, it is possible to change the bottle values to match the gas bottle to be used.

- 1] To change a calibration value, press 'OK' whilst the calibration screen is shown to allow sensor selection.
- 2] Use the up and down buttons to select a sensor to change.
- 3] To change the highlighted sensor's value, press 'OK'. The sensor's calibration value will be highlighted (Figure 31)
- 4] Press the up and down buttons to change the calibration value (press and hold the button to adjust the value more rapidly).
- 5] When the desired value is shown, press 'OK' to set the value. Repeat for any other calibration values which need to be changed.
- 6] When finished, press the 'Exit Edit' context button to return to the calibration screen and allow a calibration adjustment to be performed.

OK Set	Change	Cal?	Conc.	Hi/Lo
% O <sub>2</sub>	20.89	<input checked="" type="checkbox"/>	20.90	Hi
ppm CO <sub>2</sub>	877	<input checked="" type="checkbox"/>	896	Hi
ppm VOC	18.2	<input checked="" type="checkbox"/>	18.0	Hi
ppm CO	17.8	<input checked="" type="checkbox"/>	18.0	Hi
Back				

**Figure 31** *Adjusting the CO<sub>2</sub> Calibration Value*

### 5.12.4 Calibration adjustment reminders

When enabled, the ACG+ will show a flashing reminder beside the sensor reading when a calibration adjustment is due (**Figure 32**). The reminder is displayed when the time since the last full high and low calibration adjustment was performed exceeds the required calibration regime.

A calibration adjustment reminder will only be cleared once both a high and low calibration adjustment have been performed. Both adjustments should be performed with as little time between as possible. If not performed together, the calibration adjustment reminder will be shown based on the time of the earlier of the two adjustments.

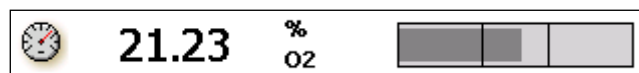

**Figure 32** *Calibration Adjustment Reminder*

The sensor calibration due date can be viewed on the sensor information screen (section 5.14)

### 5.13 Viewing device information

For ease of access, the device information screen can be accessed from the main sensor readings screen by using the right hand context button. Alternatively, to view information about the system, select 'System information' from the main menu. This will display the device information screen (Figure 33 Device Information Screen

The system information page shows the serial number of the device, information about the software version and the current date and time. Readings are also shown for the current (absolute) inlet pressure, the absolute atmospheric pressure and the flow rate of sample gas to the sensors.



The sensor reading screen can be accessed from the device information screen by pressing the right hand context button. This allows for quickly toggling between the two screens when taking measurements.

System OK	
Serial Number:	123456
Software:	v3.3 v1.0 (292970.A01)
Date / Time:	2014-04-24 13:46:50
System flow:	0.0 LPM
Atmospheric pressure:	1011.0 mbara
Open repeater ports:	True
Menu	Gas readings

**Figure 33 Device Information Screen**

### 5.14 Viewing sensor information

To view information about an individual sensor, select 'Sensor options' from the main menu and then select the sensor of interest. Next select the 'Sensor information' option. The sensor information screen will be shown as per Figure 34. The sensor information screen shows the serial number, part number and a diagnostic code for the chosen sensor. If calibration reminders apply to the particular sensor (section 5.12.4), the date when calibration is next due will be shown. Likewise, if the sensor or an element of the sensor requires routine replacement (section 5.16), the date when the replacement is next due will be shown. The sensor information screen also shows the alarms that are currently applied to the sensor including direction and set-point.

	<b>20.30</b>	%	O <sub>2</sub>	
Serial number:	MEC-758510			
Part number:	MECO2ABB			
Diagnostic code:	00000000			
Calibration due:	2011-12-18			
Replacement due:	2013-11-13			
High alarm:	▲ 22.00 %			
Low alarm:	▼ 20.00 %			
Exit	Next sensor			

**Figure 34 Sensor Information Screen for O<sub>2</sub>**

From the sensor information screen, information about the next sensor in the list can be easily displayed by pressing the 'Next sensor' context button.

## 5.15 Data-logging

If the data-logging feature is enabled on an ACG+ then it will maintain a log of system and sensor data whenever the device is powered up. Data is logged every 10 seconds and includes the system status, average, minimum and maximum readings for the 10 second period for each sensor. An ACG+ operates a 90 day rolling log. Once 90 days' worth of data is collected, the oldest day's data will be deleted so only the most recent 90 days are recorded.

Data can be downloaded into daily log files in .CSV (comma-separated values) format for easy import into popular spreadsheet applications. An example of a typical data log file is shown below. (Note that only the first sensor data is shown here. Average, minimum and maximum readings and units for each sensor will be logged).

**Table 8 Data-Log Formatting Example**

Serial Number: 012345										
Date	Time	Flow (l/m)	Atm pressure (mbarA)	Temperature (C)	O2 Average (%)	CO2 Average (ppm)	CO Average (ppm)	H2O Average (mg/m3)		
15/09/2015	11:25:12	0	983	25.1	19.1	733	0	12120		
15/09/2015	11:25:22	0	983	25.1	19.1	740	0	12119		
15/09/2015	11:25:32	0	983	25.2	19.1	741	0	12118		
15/09/2015	11:25:42	0	983	25.2	19.1	735	0	12114		
15/09/2015	11:25:52	0	983	25.2	19.1	735	0	12102		
15/09/2015	11:26:02	0	983	25.2	19.1	735	0	12063		



**NOTE: IF A SENSOR IS IN A STATE WHERE A VALID READING CANNOT CURRENTLY BE SHOW (SUCH AS WARM-UP OR CERTAIN FAULTS) THEN A BLANK ENTRY WILL BE RECORDED IN THE DATA LOG.**

### 5.15.1 Retrieving data-logs

There are two methods of downloading data-logs. To view all of the log files which are available on the system, download and delete specific logs, the ACG+ PC Software can be used as described in section 6.4.

Alternatively, for convenience, the full set of data-log files can be downloaded from the device, directly onto a USB memory stick via the USB port on the front panel. To download the data logs, prepare a USB memory stick, ensuring that there is enough space free to download logs. Each daily log file is typically 1.5MB in size, with a full 90 days of logs taking up approximately 135MB.



**CAUTION: WHEN DOWNLOADING LOGS VIA THIS METHOD, THE LOGS WILL BE STORED AUTOMATICALLY AT THE ROOT OF THE USB MEMORY STICK IN A FOLDER NAMED BY ACG+ SERIAL NUMBER AND DATE OF DOWNLOAD. ENSURE THAT ANY IMPORTANT FILES THAT MIGHT BE STORED ON THE USB MEMORY STICK ARE BACKED UP TO ANOTHER DEVICE BEFORE ATTEMPTING A DOWNLOAD.**

- 1] Once the USB memory stick is ready for downloading logs, unscrew the protective cover from the USB socket on the front panel of the ACG+ and insert the USB memory stick into the USB socket.

- 2] From the main menu, enter the 'Data-logging' sub-menu and select 'Download data to USB'. The data-log download screen will be shown as per Figure 35.

This will indicate how many logs are available to be downloaded. If there is insufficient space on the USB memory stick to download all log files then an error will be shown.

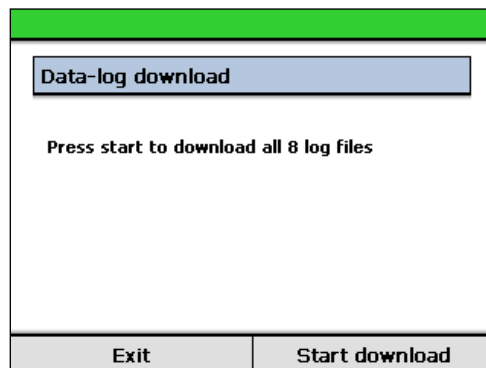

Figure 35 Data-Log Download Screen

- 3] To begin the download, press the 'Start download' context button. The progress of the download will be shown on screen as per Figure 36. The download may take several minutes depending on the number of files currently stored.

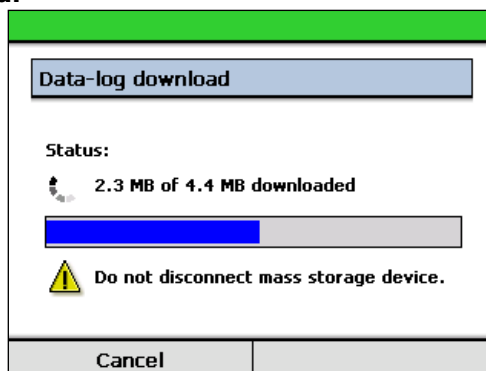

Figure 36 Data-Log Download in Progress



**CAUTION: IT IS IMPORTANT THAT ONCE A LOG DOWNLOAD HAS BEGUN, THE USB MEMORY STICK IS NOT DISCONNECTED FROM THE ACG+. UNEXPECTED REMOVAL OF THE USB DEVICE MAY CORRUPT THE DEVICE'S MEMORY AND IMPORTANT DATA MAY BE LOST.**

The data-log download screen will indicate that the download is complete once all data-logs have been downloaded.

The download can be cancelled at any time by pressing the 'Cancel' context button. It may take a few seconds to cancel the download once requested. The USB device should remain connected until the display shows that the download has been successfully cancelled. When a download is cancelled, all full data-log files that have been downloaded up until the point of cancellation will remain on the USB memory stick.

Each time a log download is performed in this way, all files will be downloaded. To avoid having to download all data-logs each time, an option to delete all current data-logs exists so that after a download, the logs may be cleared. To delete all log files, select 'Data-

logging' from the main menu and then select 'Delete all data-logs'. Confirmation is required before the logs will be deleted. Note that this operation is permanent and logs that are deleted cannot be retrieved at a later date.

## 5.16 Sensor replacement reminder

Certain ACG+ sensors have a requirement to be periodically replaced or have elements of the sensor replaced, for example, to replace a depleted electrochemical cell or to return for factory calibration. To aid with the timely replacement and/or maintenance of sensors the ACG+ provides a sensor replacement reminder feature. This feature is only effective for sensors which require periodic replacement and/or maintenance.

If the sensor is replaceable, the ACG+ will show an onscreen warning when the sensor/cell is due to be replaced as shown in *Figure 37*.



**NOTE: THE CELL REPLACEMENT FEATURE IS INTENDED TO BE USED ONLY AS A GUIDE AND CANNOT ACCURATELY DETERMINE THE LIFESPAN OF A CELL. IF A SENSOR BECOMES DIFFICULT TO CALIBRATE AFTER A PERIOD OF TIME IN SERVICE THEN IT SHOULD BE REPLACED REGARDLESS OF THE REMINDER STATUS.**

The sensor/cell replacement reminder is shown once the number of days that have elapsed since the cell was last replaced exceeds the sensor/cell replacement reminder period. The sensor replacement due date can be viewed on the sensor information screen (5.14)

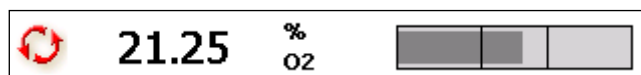

**Figure 37** Sensor Change Reminder



**NOTE: THE CELL REPLACEMENT FEATURE IS INTENDED TO BE USED ONLY AS A GUIDE AND CANNOT ACCURATELY DETERMINE THE LIFESPAN OF A CELL. IF A SENSOR BECOMES DIFFICULT TO CALIBRATE AFTER A PERIOD OF TIME IN SERVICE THEN IT SHOULD BE REPLACED REGARDLESS OF THE REMINDER STATUS.**

### 5.16.1 Replacing a cell and resetting the reminder

The sensor replacement reminder does not automatically reset once a sensor has been replaced. Once a sensor or cell has been physically replaced, the sensor/cell replacement reminder will continue to be shown and needs to be manually reset. To do this, open the main menu, select 'Sensor options' and then select the sensor that has been replaced. From the sensor's sub-menu select 'Replacement reset'. A confirmation screen will be shown explaining the implications of resetting the reminder as shown in **Figure 38**. On pressing the 'Confirm' context button, the sensor will store the current date as the date it was last replaced.



**CAUTION: ONCE THE REMINDER HAS BEEN RESET FOR A SENSOR, A REMINDER WILL NOT BE SHOWN AGAIN UNTIL THE SENSOR IS NEXT EXPECTED TO BE REPLACED. THE RESET FEATURE SHOULD ONLY BE USED IF THE SENSOR HAS BEEN PHYSICALLY REPLACED.**



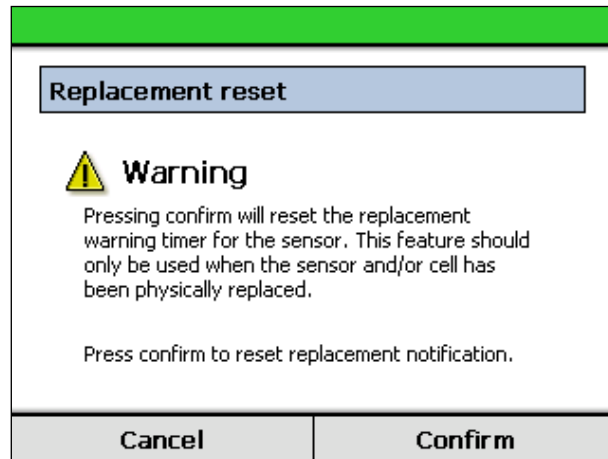

**Figure 38** Sensor Replacement Reset Confirmation Screen

### 5.17 Timed sample draw

Occasionally it may be desirable to take a sample of the ACG+ inlet gas and direct it into another gas detection device or analysis tube, for example, when analysing oil mist content. The ACG+ provides a method of drawing off a sample of the inlet gas via a software controlled sample valve. This feature can be used to set up a timed sample with a known flow which will automatically end after the defined timeout. Note that the sample draw bypasses all system filtering.

The ACG+ comes fitted with a fixed restriction prior to the sample outlet port suitable for oil mist detection using a Drager Impactor. Another restrictor kit is supplied which can be quickly fitted to provide suitable flows, for example for an Oilmist colorimetric tube (0.1l/m sample for 3 minutes).

- 1] Remove the Impactor restrictor tube from the outlet of the solenoid valve and the rear of the sample support bulkhead.**

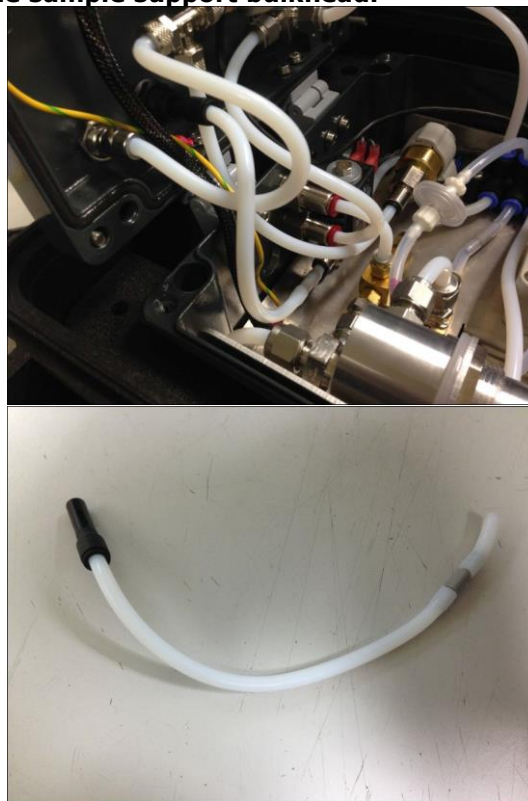

- 2] Remove the 8mm to 6mm push reducer from the Impactor restrictor tube and fit it to the 0.1l/m restrictor tube.



- 3] Refit the 0.1l/m restrictor tube to the outlet of the solenoid valve and the rear of the sample support bulkhead as shown.

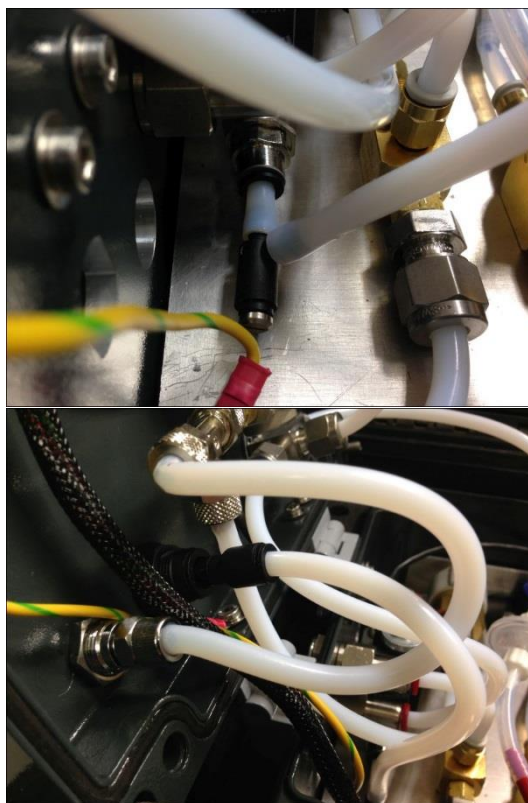

A flow meter kit (1 to 10l/m) is also available as an accessory (P0149-611) which can be fitted to the sample gas outlet port to provide a suitable flow for other sampling techniques.

The procedure for performing a timed sample draw is as follows:

- 1] Attach the target gas to the sample inlet and the measurement device or sample pipe to the gas outlet port on the ACG+ front panel (see Figure 39).
- 2] The protection label on the Dräger Impactor should not be removed until after the timed sample has been completed.

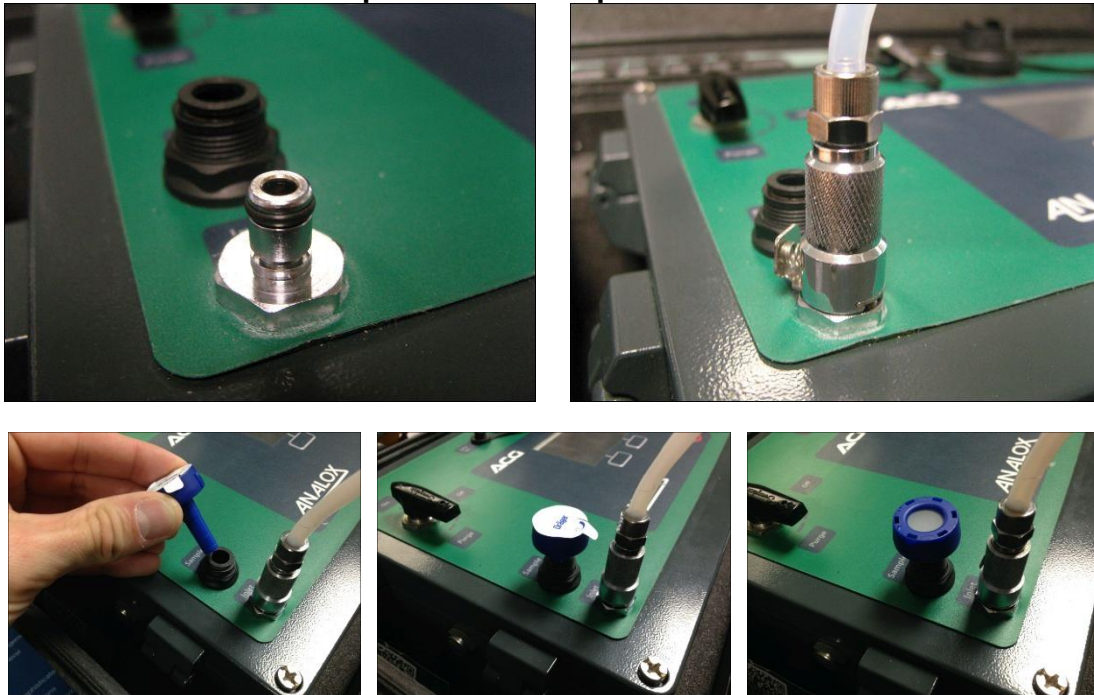

**Figure 39** A Dräger Impactor Attached to the Outlet Port for Oil Mist Testing

- 3] From the main menu select 'Timed sample' then select 'Start new sample'. The timed sample setup screen will be shown (Figure 40)

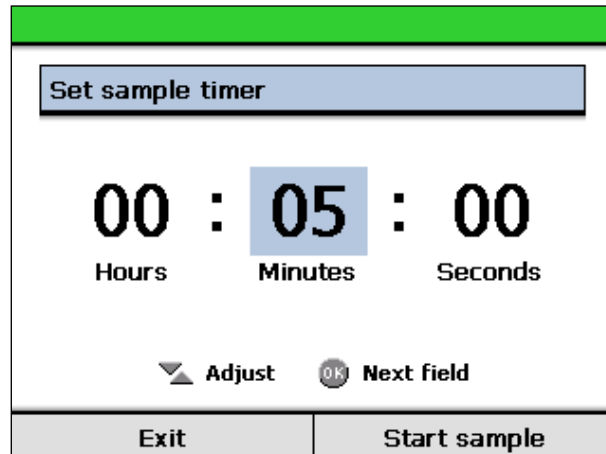
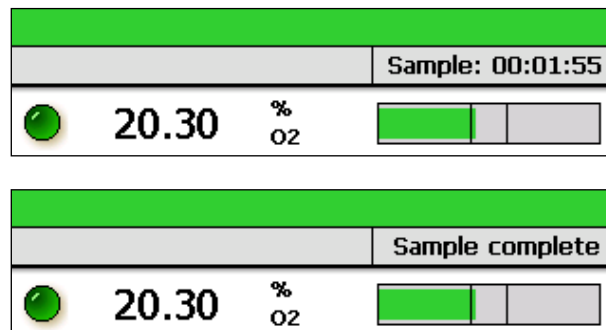

**Figure 40** Timed Sample Setup

- 4] Select the highlight hours/minutes/seconds field by pressing the 'OK' button and use the up and down buttons to dial in the desired sample time.
- 5] Press 'Start sample' to begin the timed sample. The sample valve will then open.

Throughout the sample period, the time remaining on the sample timer will be shown on the screen (Figure 41).

When the sample is complete, the ACG+ will give three beeps and the sample valve will close. The main screen shall show that the sample is complete (Figure 41).



**Figure 41** Timed Sample Progress

A timed sample can be cancelled at any time whilst it is in progress. To cancel a sample, select 'Timed sample' from the main menu and select 'Cancel sample'.

For certain sampling applications, it may be necessary to purge the sample line prior to beginning a sample. The simplest way to achieve this is to use the purge valve as described in section 0.

### **5.18 Setting the date and time**

The current date and time are stored on the device. This allows the ACG+ to log data with a date and time stamp and also allows calibration and sensor replacement reminders to be given. The date and time can be set or changed through the main menu under 'System options>Set date and time'.

Shows the date and time adjustment screen. To adjust the highlighted field, press the up and down buttons. To highlight the next field, press the set button. Once the correct date and time is shown, press the 'Accept' context button to save the date and time.

Alternatively, the date and time can be set using the PC tool (see section 6.5).



**Figure 42** *Date And Time Adjustment Screen*

## **6 Configuration**

In order to set options on an ACG+, the ACG+ software is provided to allow a device to be configured using a USB connection. The ACG software is designed to run on Microsoft Windows®.

### **6.1 Software installation**



**NOTE: BEFORE CONNECTING AN ACG+ TO A COMPUTER, THE APPROPRIATE SOFTWARE SHOULD BE INSTALLED.**

#### **6.1.1 Software requirements**

The ACG+ software is designed to run on Microsoft Windows® and has the following prerequisites:

- Windows 10® or above.
- Microsoft .NET Framework 3.5 SP1 or later.
- Microsoft Windows Mobile Device Centre 6.1 or later.

## 6.1.2 Windows® 10 Installation

### 6.1.2.1 Installing Windows Mobile Device Centre

To install the ACG+ software on Windows® 10, perform the following steps.

- 1] **Unplug all unnecessary USB devices from the computer keeping the ACG+ plugged in.**
- 2] **If not already installed, install Microsoft Windows Mobile Device Centre 6.1 or later for the appropriate version of Windows. This software can be found on the ACG+ software disc supplied with the instrument. The software installation can also be found on the Analox website under the ACG+ page.**



**NOTE:**

**WINDOWS MOBILE DEVICE CENTER MUST BE INSTALLED PRIOR TO THE INSTALLATION OF THE ACG+ PC TOOL.**

### 6.1.2.2 Installing the PC Tool

- 1] **From the ACG+ software disk, run the installer file called 'Setup'.**

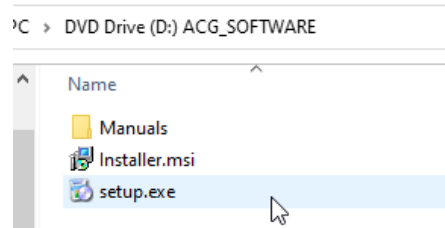

- 2] **The ACG+ installer wizard will be displayed. Follow the on-screen instructions to install the ACG+ software, click Next.**

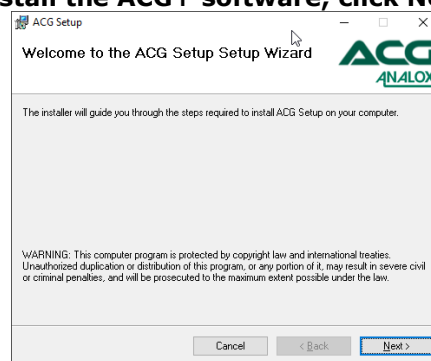

- 3] **Keep the installation folder as default, then select Everyone and click Next.**

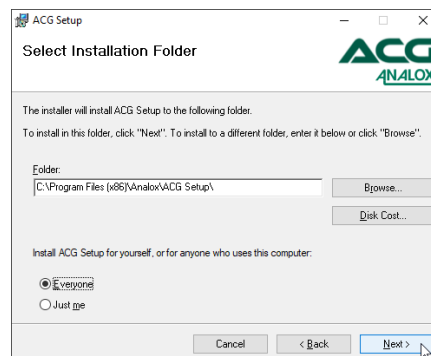

- 4] Click Next again to install the software (A warning may show, click Yes to accept).

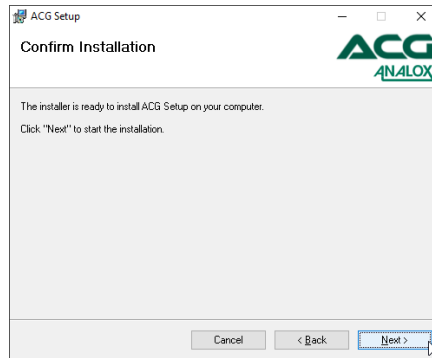

- 5] Once installed, click Close to exit the installation process.

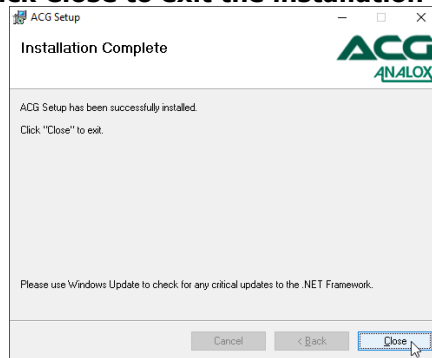



### 6.1.3 Running the software

To run the ACG+ software, select the program from the Windows® start menu, Analox folder. When the software runs without a device connected, the window shown in Figure 43.



**NOTE: ON INITIAL STARTUP, YOU MAY SEE A DELAY OF UP TO 2 MINUTES PRIOR TO THE PC TOOL OPENING, THIS IS DUE TO THE SOFTWARE LOOKING FOR APPROPRIATE DRIVERS FROM WINDOWS MOBILE DEVICE CENTER.**

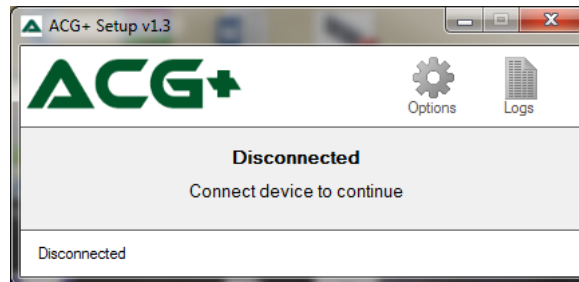

**Figure 43** ACG+ Software without Device Connected

## 6.2 Making a connection



**NOTE: THE ACG+ SOFTWARE USES MICROSOFT ACTIVESYNC® TO COMMUNICATE WITH AN ACG+. BEFORE CONNECTING TO AN ACG+, ENSURE THAT ANY OTHER WINDOWS MOBILE DEVICES OR DEVICES WHICH MAKE USE OF ACTIVESYNC® ARE DISCONNECTED FROM THE COMPUTER.**

Always connect only one ACG+ to the computer at a time. To connect an ACG+ to the computer, first open the hinged front door of the ACG+ device by loosening the four corner screws. Locate the ACG+ display module which is mounted to the inside of the ACG+ hinged front door. Connect one end of the USB cable provided to the right hand USB port (labelled 'PC') on the rear panel and connect the other end of the cable to a free USB port on the computer. Power the ACG+ device and allow it to start up.

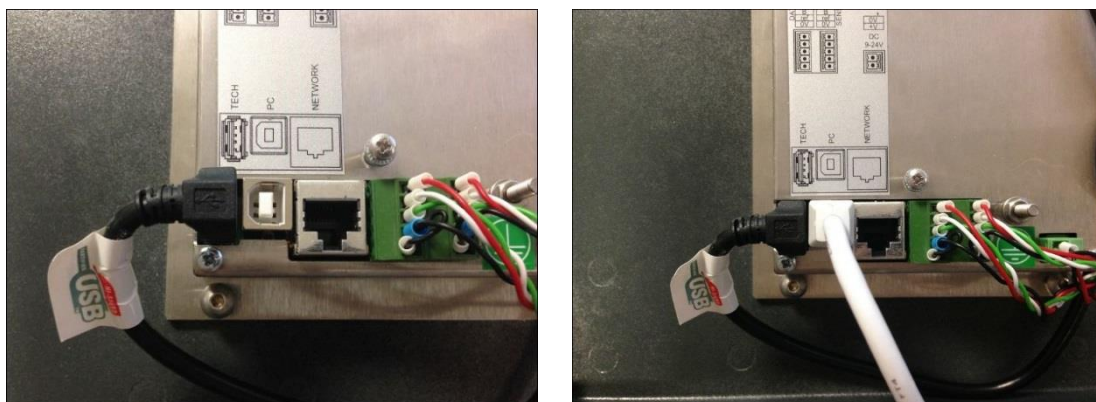

**Figure 44** Connecting a USB Cable to an ACG+

Once connected and powered, Windows® should detect the device and display an information bubble confirming the connection. On the first time connecting an ACG+ to the computer, message bubbles may be shown explaining that device drivers are being installed. This should take a few moments.

When the device connects, on Windows® 10 systems, the Windows Mobile Device Center window will be shown. This window should be closed.

If not already open, run the ACG+ software. The ACG+ software will recognise the device and read the current settings from the device. Once fully connected the window shown Figure 45 will be displayed.

### **6.2.1 Connection troubleshooting**

If the ACG+ fails to connect, see section 8.1.5 Connection troubleshooting

### **6.2.2 Disconnecting**

To disconnect an ACG+ from the computer, first wait until all settings have been saved correctly and that any file downloads have completed then remove the USB cable from the rear of the ACG+. If the USB cable was removed from the 'Tech' USB port, ensure that it is re-attached before closing and securing the ACG+ hinged front door.

### **6.3 Changing options**

On connection to an ACG+, a copy of all of the device's options is created in the ACG+ software. The options are presented over a set of tabs. To view the option tabs, click the 'Options' button. Using these tabs the options can be viewed and modified as required. No changes are made to the device's options until the changes are applied to the device. To apply any changes made click the 'Apply Changes' button. This will upload the new options to the device. The ACG+ will confirm that the options have been saved by playing a confirmation sound.

Any changes made to options can be discarded as long as they have not yet been applied to the device. To re-download the current device settings from an ACG+, click the 'Read Options' button.

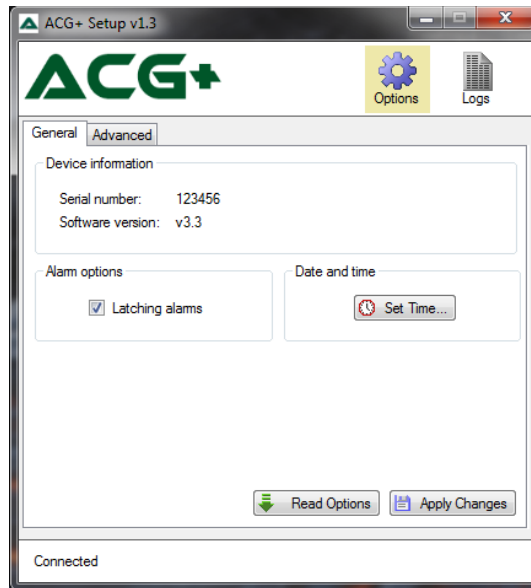

**Figure 45** ACG Software with Device Connected Showing General Options

#### **6.3.1 General options**

The general device options are displayed by clicking on the 'General' tab. As shown in **Figure 45**.

#### **6.3.2 Device information**

This shows the serial number and the software version of the connected device.

#### **6.3.3 Latching alarms**

The latching alarms checkbox enables or disables latching alarms as described in section 5.11.1.

#### **6.3.4 Date and time**

The 'Set Time...' button can be used to set the date and time on the device as described in section 6.5



**NOTE:**

**ANY CHANGES MADE TO THE GENERAL OPTIONS WILL NOT COME INTO EFFECT ON AN ACG+ DEVICE UNTIL THE 'APPLY CHANGES' BUTTON HAS BEEN CLICKED WITH THE EXCEPTION OF SETTING THE DATE AND TIME (SEE SECTION 6.5).**

## 6.4 Downloading data-logs

The data stored on an ACG+ can be downloaded using the ACG software. To view the data-log management controls, click the 'Logs' button (**Figure 45**). A list of the data-log files available on the device will be shown. The data-log files are stored by date. Each date's file contains all of the data logged whilst the device was running during a particular day. This list can be refreshed by pressing the 'Refresh' button.

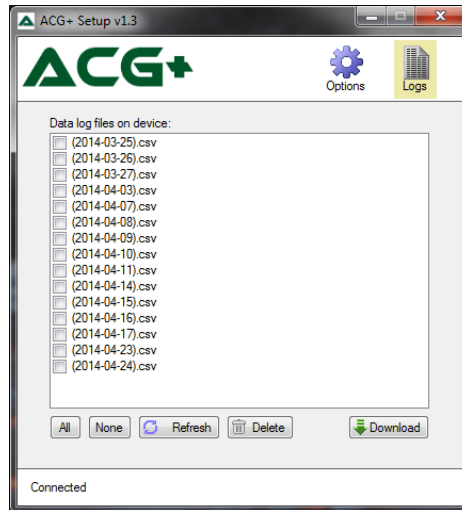

**Figure 46** The Data Logs Available on a Connected ACG+

Data-log files can be downloaded individually or in batches. To select the files that are to be downloaded, click on the checkbox next to each of the files of interest. The 'All' and 'None' buttons can be used to select or deselect all of the files respectively. Once a selection has been made, the log file download can be started by clicking the 'Download' button.



**NOTE:**

**THE TIME TAKEN TO DOWNLOAD DATA LOGS WILL VARY DEPENDING ON THE NUMBER OF LOG FILES SELECTED AND THE AMOUNT OF LOG DATA INSIDE EACH FILE. THIS PROCESS MAY TAKE SEVERAL MINUTES. IT'S SHOULD ALSO BE NOTED THAT DOWNLOADING A FULL DATA LOG MAY DOWNLOAD UP TO 150MB OF LOG DATA. PLEASE ENSURE THAT THERE IS ENOUGH STORAGE SPACE ON THE TARGET DISK BEFORE BEGINNING A DOWNLOAD.**

**Figure 47** shows a selection of files being downloaded.

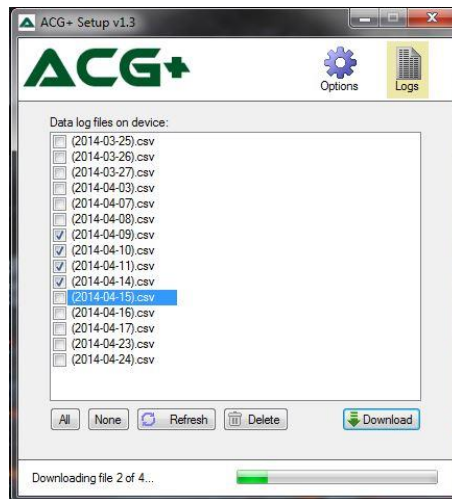
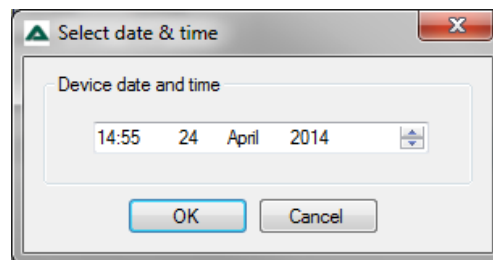

**Figure 47** *Downloading Data Logs from an ACG+*

Although the internal data-logging operates a rolling log with automatic clean-up of older data, the data-logs on the device can be managed manually using the ACG+ software. To delete unwanted files from a device, select the files for deletion and click the 'Delete' button.

## 6.5 Setting the time

The ACG+'s internal date and time is used for data-logging and for issuing various reminders. The internal clock can be set to the appropriate date and time using the ACG+ software. With an ACG+ connected to the ACG software, select the 'General' tab. Click the 'Set Time...' button. This will display the window shown in Figure 48. The default time shown will be the system date and time of the computer running the software. This date and time can be changed if required. To set the date & time on the device click OK. The ACG+ will play a sound to acknowledge that the date and time have been set successfully.



**Figure 48** *Setting the Date and Time on an ACG+*

## **7 Networking**

### **7.1 Overview**

This section describes the Ethernet Networking Communications and the Sensor Datagram of the ACG+. The ACG+ software communicates using two network protocols; TCP/IP and UDP/IP. The same Datagram is used for both protocols.

### **7.2 Connection**

For connection to the display module, a suitable networking cable should be fitted firstly through the M16 x 1.5 EMC gland in the side of the instrument, then the cable should be fitted with a suitable RJ45 connector ready for connection to the display module.

Connection should be made to the display module by plugging in the made up network cable to the 'NETWORK' port on the rear of the display module as shown.

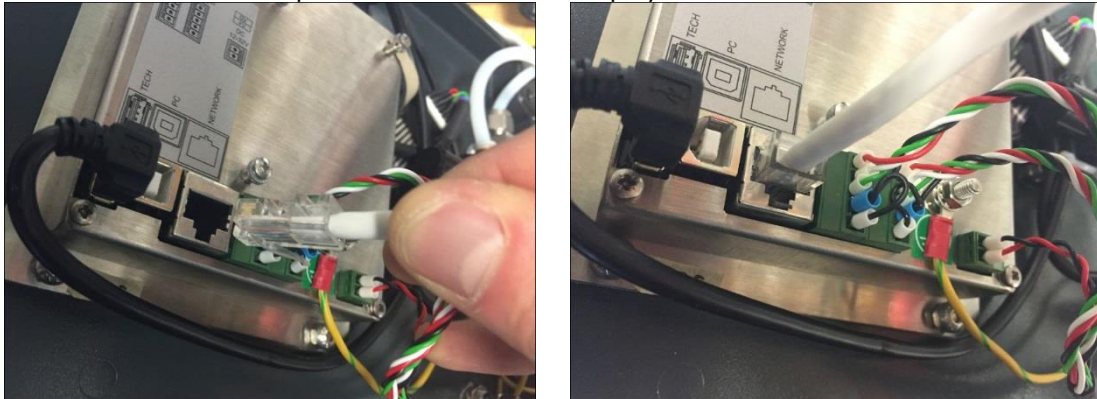

If your device supports [Auto MDI-X](#) capability, wherein a patch cable can be used in place of a crossover cable, or vice versa, and the receive and transmit signals are reconfigured automatically to yield the expected result.

If your device does not support [Auto MDI-X](#) capability, a cross over cable will be required to connect the ACG+ to your system.

### **7.3 Transmission method**

All packets transmitted via TCP/IP or UDP from the ACG are created using a C# serialisation interface. Using this method the classes storing the data for transmission are serialised into a UTF16 based XML template before transmission.

`"<?xml version="1.0" encoding="utf-16"?>"`

Although the XML document is listed as "UTF-16" the actual data is encoded into standard "UTF-8" (ASCII) during physical transmission.

## 7.4 Setting the ACG Static IP Address

The ACG can be configured to run a TCP/IP server on a specified IP Address and port, listening for client connections. The IP Address can be set in the ACG menu:

Menu -> System Options -> Server IP Settings -> Assign Static IP.

**Set static IP**

**IP Address**  
127 . 000 . 000 . 001

**Subnet Mask**  
255 . 255 . 255 . 000

Note: The device will automatically restart on Accept.

Adjust Next field

Cancel Accept

An example setting for the ACG is 127.000.000.001.  
Set the subnet mask of the ACG to 255.255.255.000

The ACG TCP/IP server uses **Port 5021** for TCP/IP communications.  
The client must use an IP address on the same subnet as the ACG.  
For example, if the ACG is set to 10.0.0.2, the client can use 10.0.0.1 or (10.0.0.3 to 10.0.0.254).  
Set the client's subnet mask to 255.255.255.0.

## 7.5 Retrieving Data using TCP/IP Requests

After a connection is established, sensor data can be requested via the command **"DataReq"** (case sensitive). The ACG will transmit one datagram per request and can handle a maximum of two live connections. The ACG datagram is large, and may get broken up into several TCP blocks at the client. The client needs a mechanism to know when the final block has been received; the server disconnect method has been chosen. The ACG TCP/IP server disconnects at the end of the transmission, causing the client to receive a zero-byte TCP/IP packet. This means that TCP/IP clients must re-establish the connection before the next **"DataReq"** command.

The sequence for retrieving a datagram is:

- Client requests connection
- Server accepts connection
- Client requests datagram
- Server sends datagram
- Client concatenates received blocks
- Server disconnects: client receives 0 length packet indicating end of data.
- Client disconnects.
- The client processes the concatenated data

The TCP/IP request **"RemClient"**. (case sensitive) is not required on the ACG since the connection is closed after each datagram request.

## 7.6 Retrieving Data using UDP

The ACG also transmits the CAGASensorDatagram every 1 second using the UDP protocol. The datagram format is the same as for TCP/IP.

The ACG transmits the UDP datagram to the broadcast IP Address (255.255.255.255) using source and destination ports both set to Port 5020.

To receive the datagram, a client must set up a UDP client listening to port 5020. The UDP datagram is received by the client as one block, so there is no need to assemble message blocks and detect end of message.

## 7.7 Datagram Structure

The ACG datagram is broken into several different sections each incorporating different aspects of the ACG functionality

The elements within the root node <CAGASensorDatagram> are:

### <CAGASensorDatagram>

Name	Data Type	Description	Example
<SerialNumber>	String	Serial number of the ACG	ACGF-1011
<SoftwareVersion>	String	ACG Software Version	3.5
<Sensors>	<i>CAGASensorData</i>	List of SensorData for each connected sensor	
<Flow>	<i>BaseSensorData</i>	Flow sensor data	
<Pressure>	<i>BaseSensorData</i>	Pressure sensor data	
<InterfaceBoard>	<i>AnaloxCAGAIInterfaceBoard</i>	Interface Board Data	

Some data types are records, described below.

### <Sensors> (*CAGASensorData*)

Holds the list of sensor data and overall fault and alarm flags

Name	Data Type	Description	Example
<SensorList>	List of <SensorData> See description below.	List of SensorData for each connected sensor	
<IsAnySensorFaultActive>	Bool	True if any fault is active	"True", "False"
<IsAnySensorFaultUnacknowledged>	Bool	True if any fault is unacknowledged	"True", "False"
<IsAnySensorAlarmUnacknowledged>	Bool	True if any alarm is unacknowledged	"True", "False"
<IsAnySensorAlarmActive>	Bool	True if any alarm is active	"True", "False"

### <SensorData>

The sensor data, status, faults and alarms for an individual sensor

Name	Data Type	Description	Example
<i>(BaseSensorData follows)</i>			
<Alarms>	<i>AlarmManager</i> See description below.		



<b>Name</b>	<b>Data Type</b>	<b>Description</b>	<b>Example</b>
<DisplayDecimalPlaces>	String	Number of decimal places the ACG will display	"One", "Two"
<MaxRange>	Float	The highest valid reading of the sensor before setting a range fault	5.0
<MinRange>	Float	The lowest valid reading of the sensor before setting a range fault	1.0
<WorkingReading>	Float	Current reading from the sensor updated at least once a second in the units specified in <WorkingUnits>	123.456
<Status>	<i>SensorStatus</i> . See description below.	Status flags for the sensor	
<i>(End of base sensor data)</i>			
<SensorMeasurand>	String	Item being measured by the sensor	"Helium", "Oxygen"
<WorkingUnits>	String	The units used for the working reading.	"mBar", "ppm"
<IsReplaceableable>	Bool	Set to true if the sensor can be replaced.	"True", "False"
<IsCalibratable>	Bool	Set to true if the sensor can be calibrated.	"True", "False"
<StatusFlags>	Hex	Hex representation of the status flags for the attached sensor.	0
<PressureStatusFlags>	Hex	Hex representation of the status flags for the attached pressure sensor.	0
<CalibrationIntervalSeconds>	Int	The number of seconds which can elapse since the last sensor calibration until the calibration due warning can be displayed.	7776000

Name	Data Type	Description	Example
<CellReplacementIntervalDays>	Int	The number of days which can elapse since the last cell replacement before a cell replacement warning will be displayed.	365
<SerialNumber>	String	Serial Number of the sensor	"MEC-123456"
<PartNumber>	String	The Analox part number of the sensor	"MECHEMBAP"

**<Alarms>** (*AlarmManager*)

Holds the alarm list and a status flag

Name	Data Type	Description	Example
<AlarmList>	List of <Alarm>. See description of <Alarm> below.	List of alarms for the sensor	
<IsLatchingEnabled>	Bool	If true the alarms will be latched.	"True", "False"

**<Alarm>**

Detailed description of an alarm condition.

Name	Data Type	Description	Example
<IsActive>	Bool	True if a fault has been identified.	"True", "False"
<IsAcknowledged>	Bool	True if a fault has been acknowledged.	"True", "False"
<IsChanged>	Bool	True if the status of the fault has changed.	"True", "False"
<Name>	String	Name for the alarm	"High Alarm"
<Setpoint>	Float	Alarm will be set as active if the reading is lower or higher than this value, depending on alarm direction	"1000.00"
<Direction>	String	Describes the direction in which the setpoint must be exceeded before an alarm is set active.	"HighGoing"

**<Status>** (*SensorStatus*)

Status data and flags for a sensor

Name	Data Type	Description	Example
<CommsFaultState>	<State> See description below.	Status of sensor comms faults	
<InternalCommsFaultState>	<State>	Status of internal comms faults (applies to dewpoint sensor)	

<b>Name</b>	<b>Data Type</b>	<b>Description</b>	<b>Example</b>
<GeneralFaultState>	<State>	Set in combination with other fault flags as a general fault flag.	
<FatalErrorState>	<State>	Set if the sensor has triggered a fatal error.	
<SensorRangeFaultState>	<State>	Set if the sensors reading is outside the acceptable range.	
<MonitorUnderRangeFaultState>	<State>	Set if the sensors reading is outside the minimum and maximum range set on the ACG.	
<PowerFaultState>	<State>	Set if the sensors power is outside the acceptable range.	
<LampFaultState>	<State>	Set if a problem has occurred with the lamp on the sensor.	
<PidFaultState>	<State>	Set if a PID error has occurred on the sensor.	
<CrcFaultState>	<State>	Set if the CRC of the program memory on the sensor has become corrupt.	
<TemperatureFaultState>	<State>	Set if the temperature on the sensor is outside of acceptable limits.	
<CalibrationFaultState>	<State>	Set if the unit has failed to calibrate.	
<IsInvalidFlow>	Bool	Set to true if the flow is outside acceptable limits.	"True", "False"
<IsInvalidTempAndPressure>	Bool	True if temperature and pressure are outside acceptable limits.	"True", "False"
<IsWarmup>	Bool	True if the sensor is currently warming up.	"True", "False"
<IsBusy>	Bool	True if the sensor is busy	"True", "False"
<IsCalibrationDue>	Bool	True if the sensor is due to be calibrated	"True", "False"
<IsChangeDue>	Bool	True if the sensor is due to be changed.	"True", "False"
<IsReadingValid>	Bool	True if the reading can be considered valid.	"True", "False"

Name	Data Type	Description	Example
<CalDueDateTime>	Date/Time	The date and time for the next calibration	2014-05-30T23:59:59
<ChangeDueDate>	Date/Time	The date and time that the cell is due for replacement	2014-05-30T23:59:59

**<Flow>**

Flow data is a record of type *BaseSensorData*. It is described in the <SensorData> section above, ending half-way down the table.

**<Pressure>**

Pressure data is a record of type *BaseSensorData*. It is described in the <SensorData> section above, ending half-way down the table.

**<InterfaceBoard>**

This record describes the status of the ACG Interface Board.

Name	Data Type	Description	Example
<CommsFaultState>	Bool	Set to true if a communications fault to the interface board has been identified.	"True", "False"
<InletSensorFaultState>	<State> See description below.	State of the inlet pressure and temperature sensors	
<EnvironmentSensorFaultState>	<State>	State of the environment pressure and temperature sensors	
<FillDisabled>	Bool	False if the Fill relay is energised	"True", "False"
<VoltageOutput1>	Bool	True to energise Output Voltage 1	"True", "False"
<VoltageOutput2>	Bool	True to energise Output Voltage 2	"True", "False"
<VoltageOutput3>	Bool	True to energise Output Voltage 3	"True", "False"
<OilFlowEnabled>	Bool	True if oil flow is enabled	"True", "False"
<Flow>	Float	Current Flow Rate	0.002914563
<InletPressure>	Float	Current Inlet Pressure	0
<InletTemperature>	Float	Current inlet temperature	0
<InletFaultCode>	Hex	Fault code of the inlet pressure/temperature sensor	1
<Pressure>	Float	Current pressure	1009.22009
<Temperature>	Float	Current temperature	24.9148445
<EnvironmentFaultCode>	Hex	Fault code of the environment pressure/temperature sensor	0
<InstrumentFlags>	Hex	Instrument status flags	0

<b>Name</b>	<b>Data Type</b>	<b>Description</b>	<b>Example</b>
<VersionString>	String	Software version number of the Interface Board	"1.0"

**<State>**

This record describes the status of a fault.

<b>Name</b>	<b>Data Type</b>	<b>Description</b>	<b>Example</b>
<IsActive>	Bool	True if a fault has been identified.	"True", "False"
<IsAcknowledged>	Bool	True if a fault has been acknowledged.	"True", "False"
<IsChanged>	Bool	True if the status of the fault has changed.	"True", "False"

## 8 Troubleshooting

### 8.1 System faults

An instrument constantly monitors itself for fault conditions. Any fault conditions that are identified will trigger a fault alarm. When a fault alarm is raised, the horn will sound immediately. Faults will be indicated on the display with the status bar coloured yellow as shown in Figure 49. Fault alarms can be muted in the same way as standard alarms by pressing the mute button.

All fault alarms are latching so if an intermittent fault is identified and subsequently cleared, the alarm will continue to be displayed and sounded until the mute button is pressed to acknowledge the fault.

Information about the fault condition identified is displayed alternating with the sensor reading if valid as shown in Figure 49 in which a sensor communication fault is shown. In cases where a fault prevents a valid reading from being obtained from a sensor then the reading will not be shown on the display and will instead be replaced by '---' interleaved with the fault code.











Sensor fault			
	21.05	% O2	
	SCF	ppm CO2	
	0.0	ppm CO	
	SCF	ppm VOC	
	21.0	mg/m3 H2O	
Menu			

Figure 49 System Showing a Fault Condition

**8.1.1 System fault conditions**

The following table explains the possible system fault conditions that may be displayed in the status bar:

**Table 9 List of System Faults and Possible Solutions**

<b>System status</b>	<b>Meaning</b>	<b>Possible solution</b>
High flow	The flow rate through the system is too high.	Check that the pressure of the sample gas being applied to the ACG+ is within specified limits (section 11.1). High flow is usually a result of low inlet pressure.
Low flow	The flow rate through the system is too low.	Check that the pressure of the sample gas being applied to the ACG+ is within specified limits (section 11.1). Low flow is usually a result of high inlet pressure. Low flow may also indicate a leak or loose connection in the internal plumbing. Check for any obvious breaks in the internal plumbing.
Sensor alarm	One or more sensor(s) has identified that its measurement is outside of the specified alarm limits (section 5.10).	Check that the alarms specified for the sensor(s) are as intended. Check the source of gas for problems which may have caused the alarm condition.
Sensor fault	One or more sensor(s) has identified a fault in its operation.	See the sensor faults table (8.1.2) for further fault diagnostics.
System fault: ESF	The system cannot properly communicate with its environment sensor.	The environment sensor may have developed a fault. This is not a user serviceable fault. Please contact your supplier.
System fault: ICF	The system has lost communication with its chassis board.	Check that all connections between the display module and the chassis board are secure. Restart the ACG+ device to see if the fault clears. If the fault persists, contact your supplier for repair advice.

### 8.1.2 Sensor fault conditions

The following table explains the possible sensor specific fault conditions that may be displayed for each sensor:

**Table 10 List of Sensor Faults and Possible Solutions**

Sensor status	Meaning	Possible solution
CAL	The sensor has detected that its two calibration points are too close together to give a sensible reading.	Perform a full calibration of the sensor, ensuring that the high and low calibration gases are sufficiently different in value with respect to the specified sensor range (section 10.1). A correct calibration should clear this fault. If this fault persists, it may be necessary to replace the electrochemical cell if the sensor is of this type (section 10). Alternatively, exchange the sensor for a spare of the same type, if available and contact your supplier for repair advice.
ICF	The sensor has developed an internal communications fault.	The most likely source of this fault is the connection between the H2O sensor and the chassis board. Check that this connection is correctly made.
RNG or SRF	The sensor's reading is outside of acceptable range.	This problem can often be solved by a full calibration of the sensor. If this problem persists then it may be a symptom of a sensor failure. Exchange the sensor for a spare of the same type, if available and contact your supplier for repair advice.
SCF	The ACG+ has lost serial communications with the sensor.	Check that the wired connection between the sensor showing the fault and the chassis board is made correctly.
CRC, FTL, LMP, PID, PWR, TMP or UKN	A sensor failure condition has been observed.	Restart the ACG+ device to see if the fault clears. If the fault persists, exchange the sensor for a spare of the same type, if available and contact your supplier for repair advice.

### 8.1.3 Calibration adjustment failures

When making a calibration adjustment for a sensor (section 5.12.1) the calibration request can sometimes be rejected by the sensor. There are several reasons why an adjustment can be rejected. These are as follows:

An inappropriate concentration of gas has been applied for the calibration point. For example, a full scale gas has been applied when attempting to perform a low calibration adjustment.

The concentration of gas specified by the user does not match the concentration of the calibration gas.

The amount by which the calibration value differs from the current sensor reading is too great.

The electrochemical cell (oxygen or carbon monoxide) has depleted over time. Its output may have dropped too far to perform an adequate adjustment. This can be an indicator that the cell should be replaced, even if the cell replacement warning is not yet shown.

The PID detector (VOC sensor) may have become overly dirty due to exposure to oil or other contaminants.

To remedy a calibration failure the following corrective measures can be attempted.

Check that the gas value being entered for the adjustment corresponds to the concentration given on the calibration bottle.



Check that an appropriate gas concentration is being applied for the type of calibration (low calibration close to minimum sensor range and high calibration close to maximum sensor range).

Check that there is no flow warning currently being shown. See Table 9 for information about flow faults.

Check that there are no other sensor faults currently shown.

For O2 or CO sensor, replace the sensor's electrochemical cell (section 10.1).

For VOC sensor, clean or replace the PID lamp component (section 10.1).

If the problem persists, please contact your supplier for assistance.

### **8.1.4 Diagnostic logging**

In instance of system faults, it may be necessary to provide more diagnostics information to a service engineer. All instances of fault conditions that are identified will be logged to the instrument's diagnostics log. The diagnostics log can be downloaded using the ACG+ software. To download the log, connect to the device as described in section 6.4. Access the 'Advanced' tab and click 'Download diagnostics log...'. This will give the option to specify a save location for the log file.

### **8.1.5 Connection troubleshooting**

#### **8.1.5.1 ActiveSync Drivers**

If the ACG+ fails to connect try the following:

- 1] Disconnect the ACG+ from the computer.**
- 2] Go to the folder C:\Program Files\Microsoft ActiveSync\Drivers and look for the file called wceusbsh.sys**
- 3] Select this file, copy it and paste it into the following folder C:\Windows\System32\drivers**
- 4] Restart the computer.**
- 5] When restarted, connect the powered up ACG+ to the computer**
- 6] Follow the user manual instructions for installation of the device drivers. This time the installer should locate the correct file and install correctly.**

#### **8.1.5.2 Windows Mobile Device Center Connection Issues – Windows 10**

The PC tool requires Windows Mobile Device Center to connect to the ACG unit. Once installed, the following guide can be used to resolve connection issues for Windows 10.

- 1] Update the Windows Mobile-2003-based device connectivity service:**
  - Open the start menu and type in Services followed by 'Enter' to launch the Services Console.
  - Scroll down to the Windows Mobile-2003-based device connectivity service and double click to open the settings.
  - Change Startup type to Automatic.
  - On the Log On tab, enable the Local System Account option and enable the Allow service to interact with desktop option.
  - On the Recovery Tab, set First failure, Second failure, and Subsequent failures to Restart the Service.
  - Click on Apply and you will be notified this setting won't take effect until the service is restarted.
  - Click OK to close the window.

- Do not restart the service yet as you will also need to update the below service first. Proceed to step 2 below.

**2] Update the Windows Mobile-based device connectivity service:**

- Double click the Windows Mobile-based device connectivity service to open the settings for it.
- On the Log On tab, enable the Local System Account option and enable the Allow service to interact with desktop option.
- On the Recovery Tab, set First failure, Second failure, and Subsequent failures to Restart the Service.
- Click on Apply and you will be notified this setting won't take effect until the service is restarted.
- Click OK to close the window.
- Right-click this service and choose Restart. This will restart the service with the new changes.
- Right-click the Windows Mobile-2003-based device connectivity service and choose Restart to apply its changes.
- Two Reg keys need to be added. To do so open a Command prompt as admin and run the following commands:
- `REG ADD HKLM\SYSTEM\CurrentControlSet\Services\RapiMgr /v SvcHostSplitDisable /t REG_DWORD /d 1 /f`
- `REG ADD HKLM\SYSTEM\CurrentControlSet\Services\WcesComm /v SvcHostSplitDisable /t REG_DWORD /d 1 /f`

**3] Reboot the PC.**

## 9 Recommended spares and accessories

**Table 11** *List of Spares*

Item	Description	Part no.
1	VOC in-line filter (6mm inlet/outlet)	6000-0096
2	Internal particulate filter	2533-1008
3	MEC O2 full sensor module	MECO2ABAP
4	MEC O2 cell (electrochemical)	9100-9212-9HM
5	MEC CO full sensor module	MECCOEBAP
6	MEC CO sensor PCB	MEC-233B
7	MEC CO cell (electrochemical)	9100-2030S
8	MEC VOC full sensor module	MECVOCBAP
9	MEC VOC cell (PID)	9100-2060S
10	MEC VOC sensor PCB	MEC-233C
11	Water vapour sensor	6000-0094
<b>Replacement VOC sensor parts</b>		
12	Disposable electrode stack	9100-2060/ES
13	10.6 eV replacement lamp	9100-2060/LP
14	Replacement spring	9100-2060/SP
<b>Service parts</b>		
15	5S3 CO2 full sensor module (0-1000ppm range)	A5S3ASN8A (See note)
16	5S3 CO2 full sensor module (0-10000ppm range)	A5S3ALN8A (See note)
17	ACG+ Display Module – Configured for CO2, O2, CO, VOC and water vapour	ACGSDA/1 (See note)
18	ACG+ Display Module – Configured for CO2, O2, CO and VOC	ACGSDA/2 (See note)
19	ACG+ Display Module – Configured for CO2, O2, CO and water vapour	ACGSDA/3 (See note)
20	ACG+ Display Module – Configured for CO2, O2, CO	ACGSDA/4 (See note)
21	Replacement oring for sensor flow adaptor	2323-0017X



**NOTE:** **ACG+ TO BE RETURNED TO ANALOX FOR REPLACEMENT OR SERVICE**

**Table 12 List of Accessories**

Item	Description	Part no.
1	External PSU, 24VDC, 1.5A, 36W for connection to front panel via panel mount connector (For use with Portable & Fixed variants)	ACGPEXTPSU
2	External PSU, 24VDC, 2.7A, 65W for connection through gland direct onto interface PCB (For use with fixed variants)	ACGEXTPSU
3	Li-Ion rechargeable battery pack kit, universal (Includes charger and battery casing – for portable variants)	P0149-605LU
4	Spare Li-Ion rechargeable battery pack (Includes battery casing lid – for portable variants)	P0149-605LS
5	NiMH rechargeable battery pack kit, universal (Includes charger and battery casing – for portable variants)	P0149-605NU
6	Spare NiMH rechargeable battery pack (Includes battery casing lid – for portable variants)	P0149-605NS
7	Inlet/Calibration adaptor	6000-0201
8	0.5LPM 110L bottle regulator	Contact Analox or source locally
9	Zero calibration gas (not including CO Sensor) – 8% oxygen, balance nitrogen	Contact Analox or source locally
10	Zero calibration gas (For CO Sensor only) – 20.9% oxygen balance nitrogen. Oxygen only span calibration gas (For part number ACGPABXXXXX)	Contact Analox or source locally
11	Nitrogen background span calibration gas, (18ppm carbon monoxide, 18ppm isobutylene, 20.9% oxygen, 900ppm carbon dioxide, balance nitrogen)	Contact Analox or source locally
12	Carbon dioxide only span calibration gas (For part number ACGPABXXXXX) – 9000ppm carbon dioxide, balance nitrogen	Contact Analox or source locally
13	Pressure regulator, compact piston sensed, 300bar max inlet, 0 to 7bar adjustable outlet (Suitable 1/8" NPT fittings required for inlet and outlet), complete with pressure relief valve set at 7.5bar	6000-0164
14	Combined beacon/sounder, 24V DC, IP65 (For fixed variant)	2562-0008
15	30mm open ended spanner	9300-1020
16	Gastec Airtec Tube (Oil Mist) 109A, Pk10	9100-3500
17	Rubber Tube Holder for colorimetric tubes	GAS357
18	8mm to 4mm Push fit reducer (Required for item 17)	6000-0165
19	Drager Oil Impactor, Pk10	9100-3501
20	Override Keyswitch & Gland Kit	P0149-610
21	Humidifier Kit	P0149-660
22	External flow meter sample support kit	P0149-611
23	VOC electrode stack removal tool	9300-1021
24	VOC lamp cleaning kit	9300-1022
25	ACG+ Fixing Kit	P0075-615

## 9.1 Service requirements

The following tables specify the description of the service parts and their associated part numbers for the 6 monthly, 12 monthly and 24 monthly service requirements.



**NOTE: THE SPARES SHELF LIFE IS 3 MONTHS FROM THE DATE OF DESPATCH FROM ANALOX.**

**Table 13 6 monthly service for ACG+**

Item	Description	Part no.
1	10.6 eV replacement lamp	9100-2060/LP
2	Internal particulate filter	2533-1008
3	VOC electrode stack removal tool	9300-1021

**Table 14 12 monthly service for ACG+**

Item	Description	Part no.
1	10.6 eV replacement lamp	9100-2060/LP
2	Internal particulate filter	2533-1008
3	VOC in-line filter (6mm inlet/ outlet)	6000-0096
4	VOC electrode stack removal tool	9300-1021

**Table 15 24 monthly service for ACG+**

Item	Description	Part no.
1	10.6 eV replacement lamp	9100-2060/LP
2	Internal particulate filter	2533-1008
3	VOC in-line filter (6mm inlet/ outlet)	6000-0096
4	MEC O2 cell (electrochemical)	9100-9212-9HM
5	MEC CO cell (electrochemical)	9100-2030S
6	Water vapour sensor (Capacitive)	6000-0094
7	Replacement o'ring for sensor flow adaptors (5 off)	2323-0017X
8	VOC electrode stack removal tool	9300-1021

## 10 Maintenance requirements

Certain elements of the ACG+ system require regular, preventative maintenance to ensure optimum operation. Table 13 shows the maintenance that is required and the scheduled interval for performing the maintenance.

**Table 16 Maintenance Schedule of ACG+ Components**

System component	Maintenance required	Maintenance interval
Oxygen sensor	Replace electrochemical cell	Approx. 2 years or as required.
Carbon monoxide sensor	Replace electrochemical cell	Approx. 2 years or as required.
VOC sensor	Clean PID lamp and electrode stack	As required, recommended every 3 months.
	Replace PID lamp or whole PID cell	Lamp - 5,000 hours (~6 months) Cell - 5 years or as required.
Carbon dioxide sensor	Replace sensor	6 years
Water vapour sensor	Replace water vapour sensor	2 years
Activated charcoal filter	Replace filter	1 year
PID particulate filter	Replace filter	6 months or as required (Depending on how dirty sample is)
Sensor flow adaptor orings	Replace oring	Check yearly and replace if required



**NOTE:**

**A 'RECOMMENDED SPARES AND MAINTENANCE INTERVALS' (P0149-955) GUIDE WILL BE PROVIDED WITH THE ACG+, THIS INCLUDES RECOMMENDED MAINTENANCE INTERVALS AND REPLACEMENT PART NUMBERS. WE RECOMMEND THIS DOCUMENT IS USED TO TRACK ANY MAINTENANCE CARRIED OUT ON THE ACG+.**

### 10.1 Sensor & filter replacement

Before attempting to replace any filters or sensors ensure that the ACG+ is switched off and the gas supply has been isolated and disconnected. Using a Pozi-drive screwdriver loosen the 4 enclosure lid screws and open the lid.



**10.1.1 Oxygen cell replacement**

The part number for your sensor's replacement cell is: **9100-9212-9HM**

When a replacement cell is received check that the cell has not leaked. The cells are themselves sealed and do not under normal circumstances present a health hazard however if leakage of the electrolyte has occurred use rubber gloves and wear chemical splash goggles to handle and clean up. Rinse contaminated surfaces with water. If contact is made with the electrolyte, please refer to Section 1.

**1] Remove the flow adaptor from the sensor inlet.**

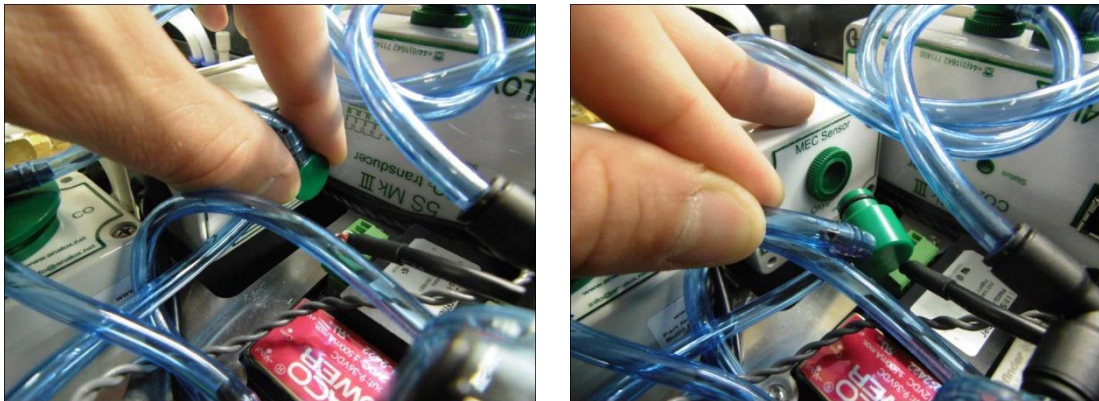

**2] Loosen the corner screws of the enclosure and remove the lid.**

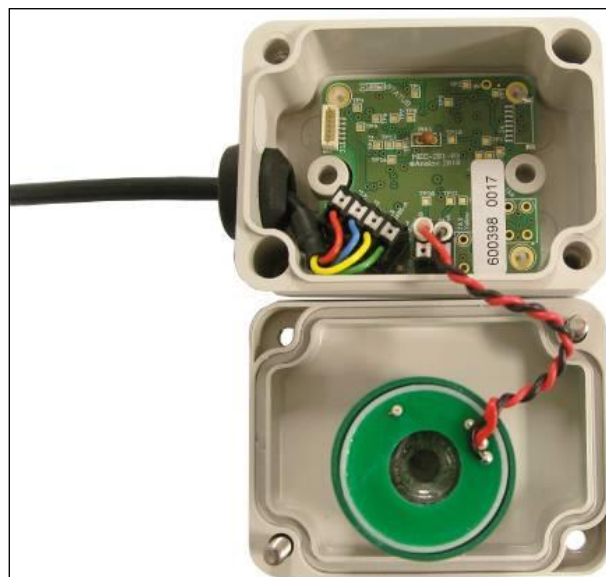

- 3] Using a terminal screwdriver push down the clamp release button to release the clamp and gently pull the cell wire from the clamp. Repeat this for both the red and black wires.

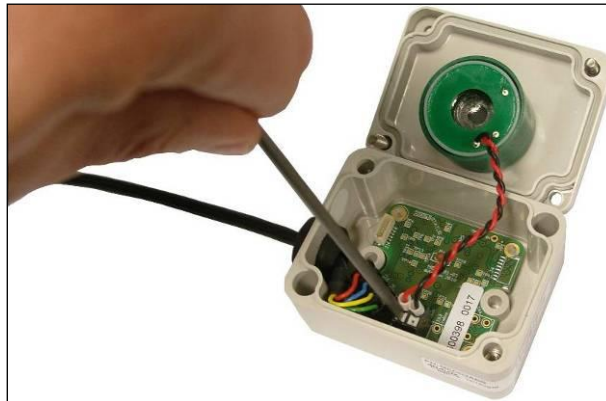

- 4] Unscrew the green locking ring from the chimney of the cell housing and remove from the enclosure lid.



- 5] Fit the new cell in to the enclosure lid and secure in place using the locking ring.





- 6] Using a terminal screwdriver, push down the clamp release button to release the clamp. Push the ferrule of the cell wire in to the clamp and remove the screwdriver from the clamp release button. Gently pull on the wire to ensure that the wire is held by the clamp. Repeat this for both the red and black wires, taking note of the correct polarity as shown below.

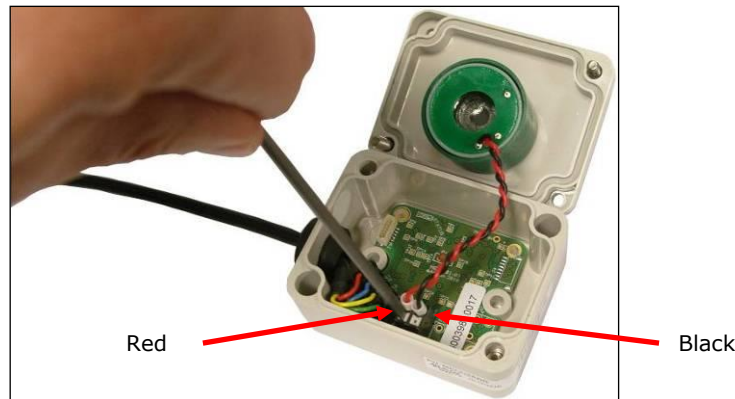

- 7] Refit the enclosure lid in place and secure in place using the corner screws.

- 8] Refit the flow adaptor into the sensor inlet



**NOTE:**

**FOLLOWING AN OXYGEN CELL REPLACEMENT A FULL CALIBRATION MUST BE PERFORMED. SEE SECTION 5.12 FOR DETAILS. ALSO, A REPLACEMENT NOTIFICATION RESET SHOULD BE PERFORMED. SEE SECTION 5.16.1 FOR DETAILS.**

### 10.1.2 Carbon monoxide cell replacement

The part number for your sensor's replacement cell is: **9100-2030S**

When a replacement cell is received check that the cell has not leaked. The cells are themselves sealed and do not under normal circumstances present a health hazard however if leakage of the electrolyte has occurred use rubber gloves and wear chemical splash goggles to handle and clean up. Rinse contaminated surfaces with water. If contact is made with the electrolyte, please refer to Section 1.

- 1] Remove the flow adaptor from the sensor inlet.

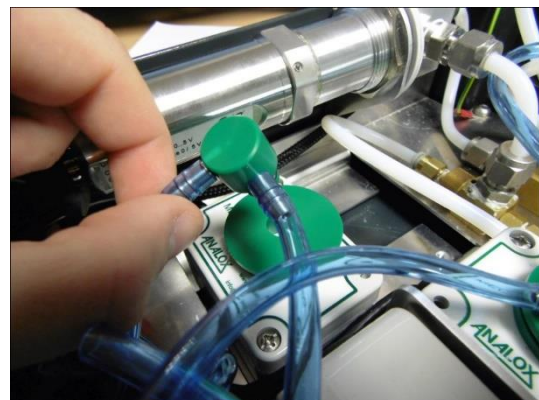
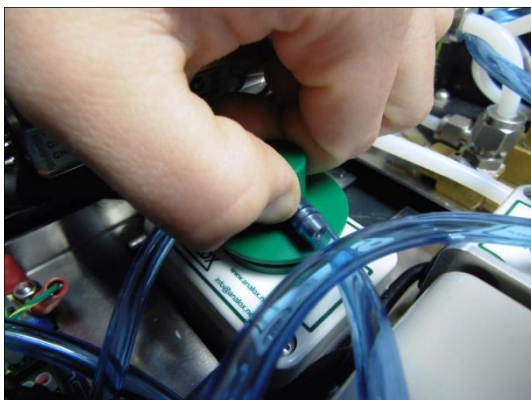

- 2] Use a flat blade screwdriver to pop out the cell holder from the sensor bulkhead fitting.

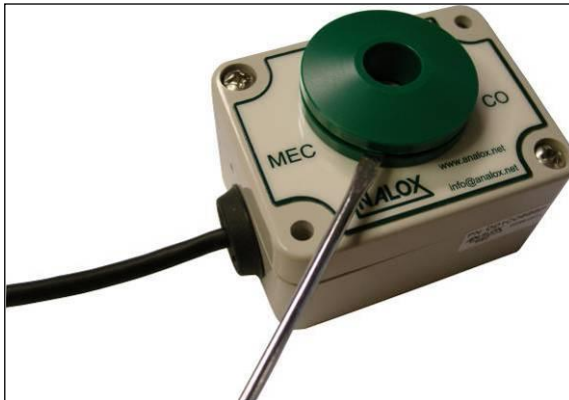

- 3] Rotate the cell PCB connector clockwise to release from the cell holder.



- 4] Disconnect the cell from the PCB connector.



- 5] Connect the new cell to the PCB connector (Note that it will only connect in one orientation).

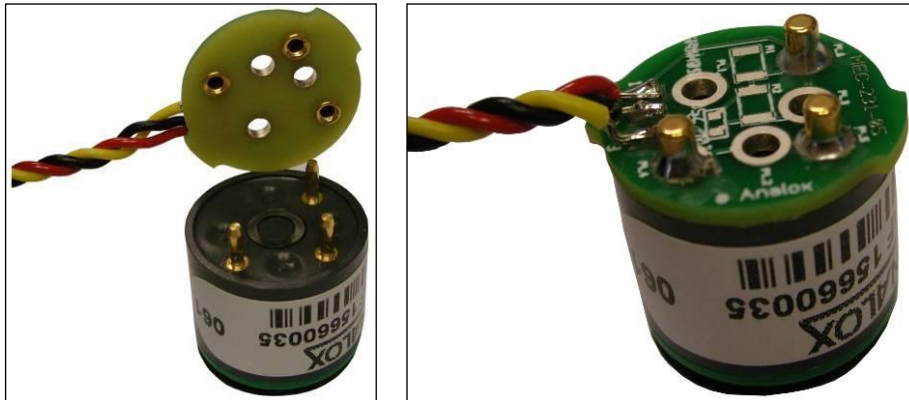

- 6] Fit the cell in to the housing and rotate anti-clockwise to lock in place.
- 7] Refit the cell holder into the sensor bulkhead.
- 8] Refit the flow adaptor into the sensor inlet.



**NOTE:**

**FOLLOWING A CARBON MONOXIDE CELL REPLACEMENT A FULL CALIBRATION MUST BE PERFORMED. SEE SECTION 5.12 FOR DETAILS. ALSO, A REPLACEMENT NOTIFICATION RESET SHOULD BE PERFORMED. SEE SECTION 5.16.1 FOR DETAILS.**

### 10.1.2.1 Replacing the CO cell PCB (MEC-233B)

- 1] Remove the flow adaptor from the sensor inlet.

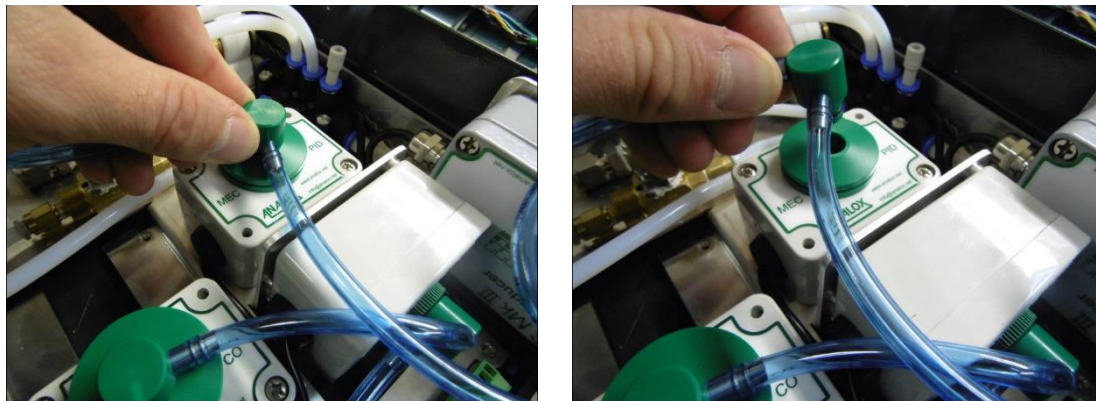

- 2] Use a terminal screwdriver to pop out the sensor holder from the sensor bulkhead fitting.**



- 3] Rotate the CO PCB connector clockwise to release from the CO holder.**



- 4] Disconnect the CO cell from the PCB connector.**

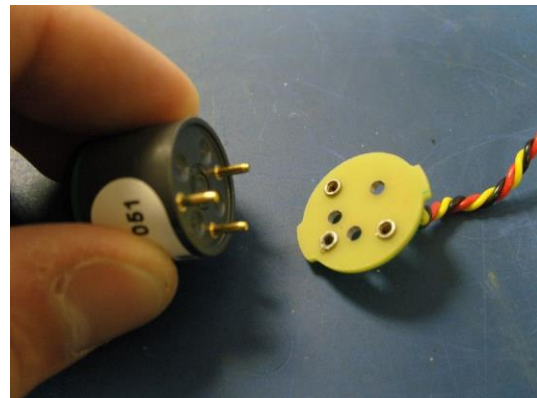
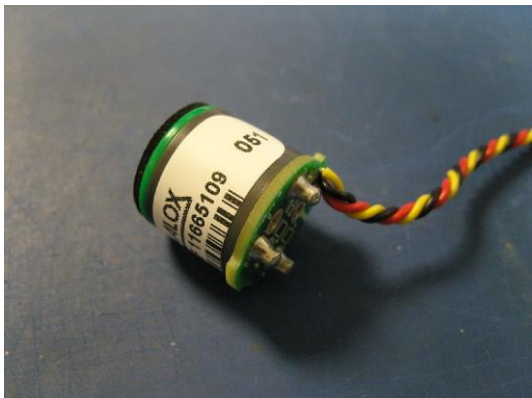

- 5] Remove the lid from the CO sensor housing and feed the cell PCB through the bulkhead.**



- 6] Disconnect the damaged cell PCB wiring loom from the MEC PCB connector.**

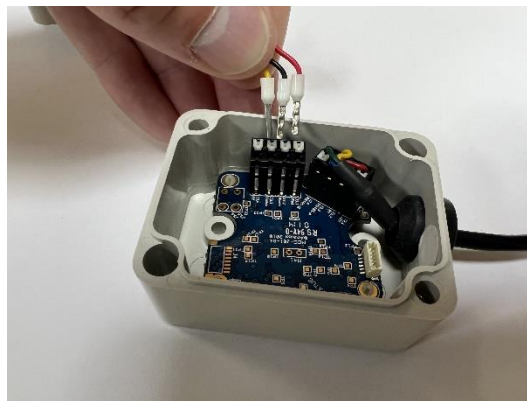

- 7] Connect the sensor wires of the new cell PCB to the corresponding 'Red', 'Black' and yellow terminals of connector J3.**

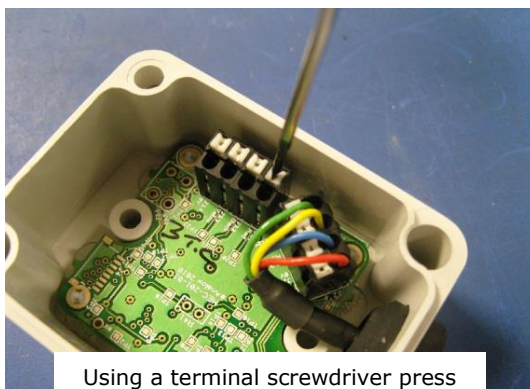

Using a terminal screwdriver press firmly down on the terminal clamp button to open the clamp.

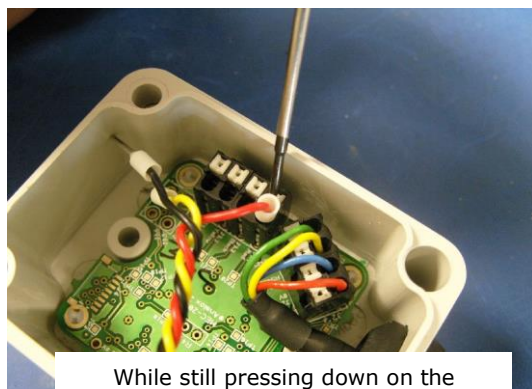

While still pressing down on the terminal clamp button insert the bootlaced wire into the terminal clamp as shown.

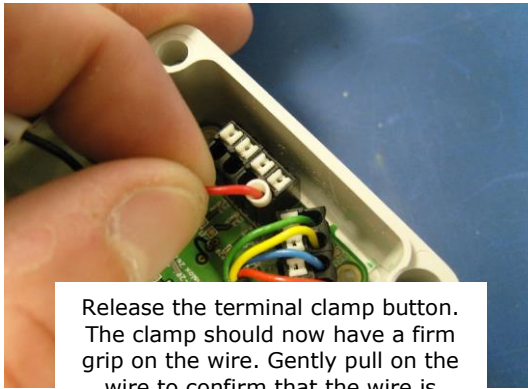

Release the terminal clamp button. The clamp should now have a firm grip on the wire. Gently pull on the wire to confirm that the wire is firmly held. If not repeat the steps shown until the wire is held firmly.

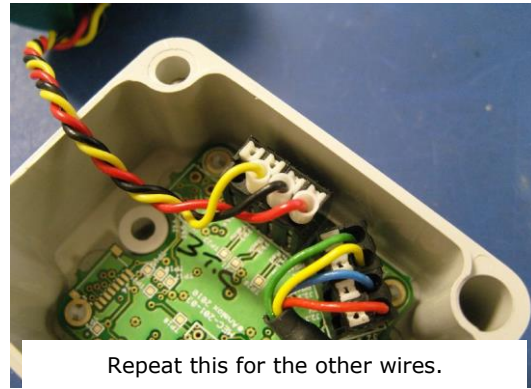

Repeat this for the other wires.

**8] Feed the cell PCB through the bulkhead and refit the lid.**



**9] Connect the CO cell to the new PCB connector. Note that it will only connect in one orientation.**



**10]Fit the cell in to the housing and rotate anti-clockwise to lock in place.**

**11]Refit the cell holder into the sensor bulkhead.**

**12]Refit the flow adaptor into the sensor inlet.**

### **10.1.3 VOC maintenance**

Maintenance of the VOC sensor can be done by the following methods, clean or replace the lamp, or replace the electrode stack. Cleaning the lamp should be performed as required if the sensitivity of the sensor reduces over time. Replacement of the PID lamp should be performed after 5000 hours of use.

Replacement of the electrode stack should be performed only if the sensor has been damaged by contamination.

The lamp and electrode stack are both part of the PID component of the sensor. The cleaning and replacement processes are documented below.

#### **1] Remove the flow adaptor from the sensor inlet.**

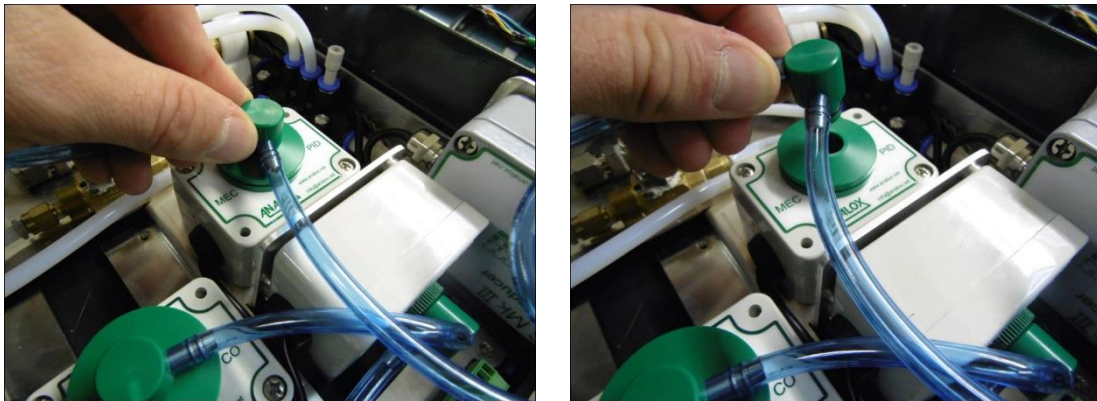

#### **2] Remove the sensor housing from the MEC and then remove the sensor from the housing by twisting the PCB on the rear of the sensor, remove the PCB from the sensor**

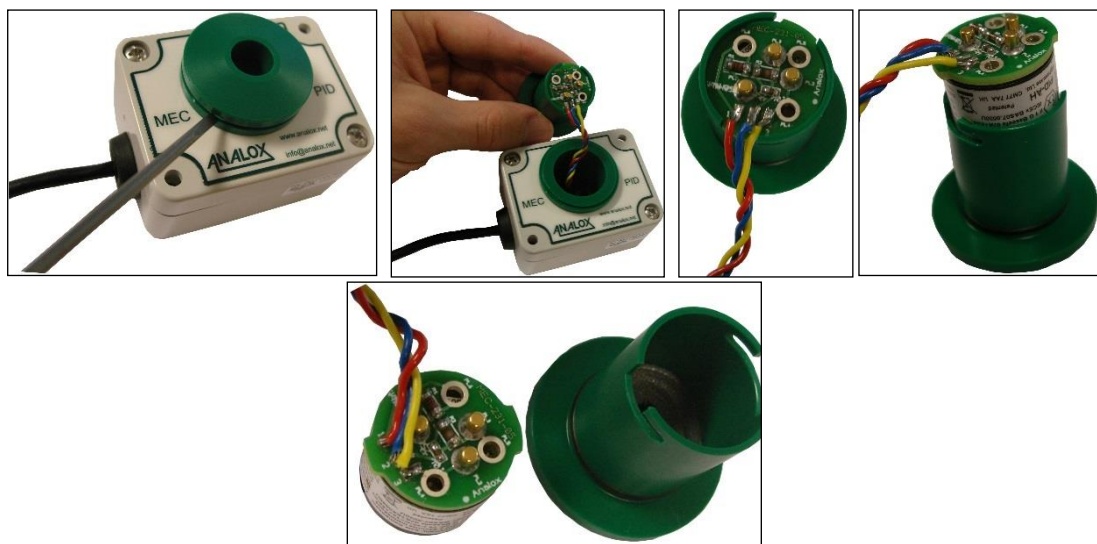

- 3] Using the stack removal tool (9300-1021) insert the ends of the tool into the slots on the sides of the sensor as shown, keeping a finger on top of the stack so as it does not spring away from the sensor and so that the spring and lamp cannot pop out upon removal.



- 4] Carefully remove the lamp from the sensor, making sure that the window of the lamp is not touched.

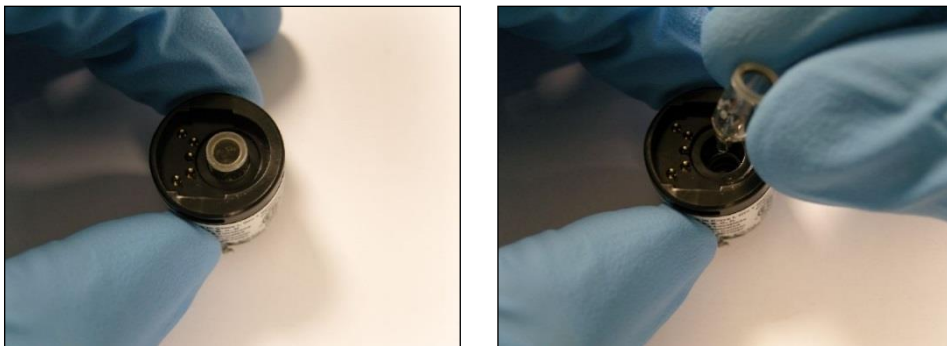

- 5] Using the lamp cleaning kit (9300-1022) and suitable protective clothing, open the container of cleaning compound, with a clean cotton bud, apply a small amount to one end.

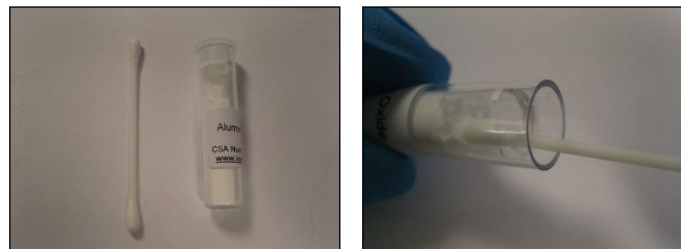

- 6] Using a circular action, clean the lamp by applying light pressure to the lamp window (do not touch the lamp window with fingers), continue polishing until a light squeaking can be heard.

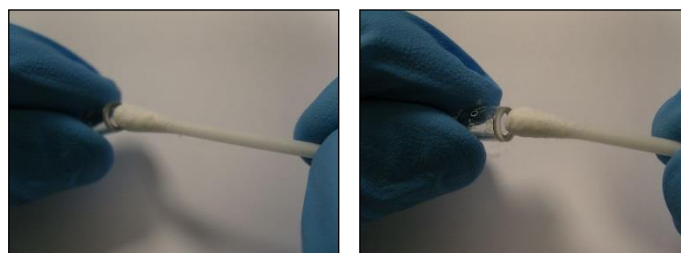



- 7] Remove any residual cleaning compound from the lamp using the clean end of the cotton bud.
- 8] Ensure that the lamp is completely free from any signs of contamination prior to refitting.
- 9] Carefully place the lamp into the rear recess of the electrode stack, this will be held by the O-ring seal in the electrode pellet.

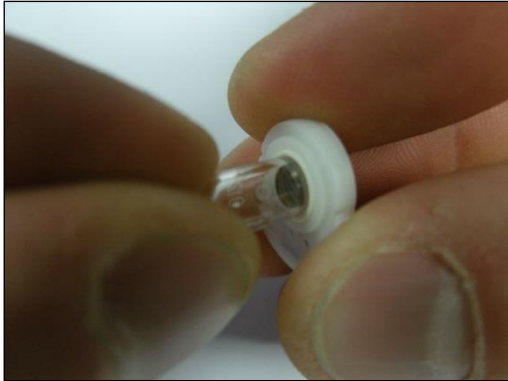

- 10] Take the electrode stack and the mated lamp and insert back into the sensor housing, push home until the electrode stack snaps into place, the top of the electrode stack should be flush with the top of the sensor housing.

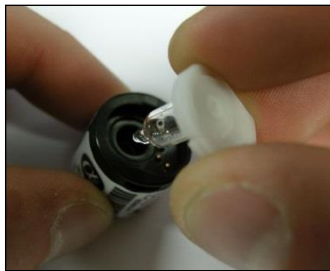

**NOTE:**

**FOLLOWING A VOC PID LAMP REPLACEMENT OR CLEANING, OR REPLACING THE ELECTRODE STACK A FULL CALIBRATION MUST BE PERFORMED. SEE SECTION 5.12 FOR DETAILS.**

### 10.1.4 Water vapour sensor replacement

The part number for the replacement water vapour sensor is: **6000-0094**

- 1] **Disconnect the cable from the end of the water vapour sensor.**



- 2] **Using a 30mm spanner (part number 9300-1020), loosen the sensor from its housing and unscrew the sensor fully from its mount. Take care when performing this step as the sensor head is delicate.**

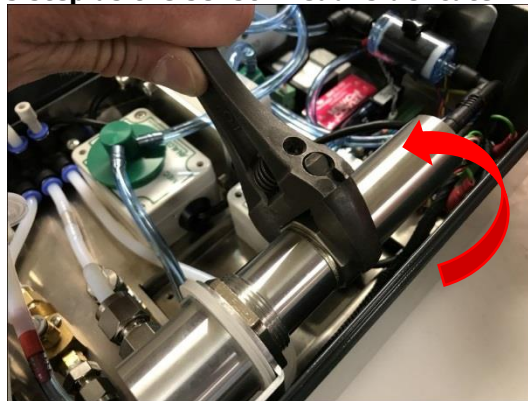

- 3] **Unscrew the protective cap from the new sensor and place it over the sensing head of the removed sensor.**



- 4] **Ensure that the dowty washer is fitted to the new sensor as shown and insert the new sensor into the sensor housing, taking care not to damage the sensor head. Screw the sensor into its mount and fully tighten using a 30mm spanner**

- 5] Re-connect the cable to the new sensor, into the port labelled 'II', checking for correct orientation. Push the connector in full to ensure it is secure.

## **10.2 Filter replacement**

The ACG+ has two types of user changeable filters. These are the internal activated charcoal filter and an internal hydrophobic particulate filter.

### **10.2.1 Activated charcoal filter replacement**

The activated charcoal filter is fitted to absorb any VOCs present in the gas sample before the carbon monoxide content in the gas is measured by the carbon monoxide sensor. The carbon monoxide sensor is cross-sensitive to VOCs so this must be filtered out before gas sample is passed over the carbon monoxide sensor to ensure accurate measurement is made.

The procedure for changing the activated charcoal filter is as follows.

- 1] Disconnect both 6mm elbow push fittings from filter.

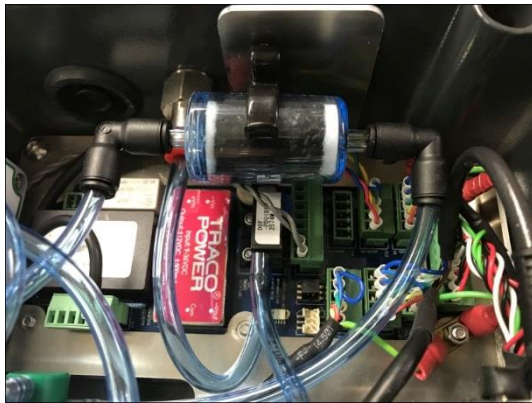

- 2] Remove filter from clip and remove the elbows from the filter.



- 3] Reverse the above process to fit a new filter.

### 10.2.2 Particulate filter replacement

The particulate filter is used to remove larger particles of VOC's as they can after time block the inlet to the PID sensor, thus making the sensor read erratically or not read at all.

The procedure for changing the particulate filter is as follows:

- 1] **Unscrew the filter from both of the male and female luers attached to the 6mm pipework from the inlet manifold.**



- 2] **Reverse the above process to fit a new filter.**

### 10.3 Service requirements

Certain elements of the ACG+ system are recommended to be replaced every six years to ensure optimum operation. Table 17 Service Schedule of ACG+ Components below shows the maintenance that is required and the scheduled interval for performing the maintenance.

**Table 17 Service Schedule of ACG+ Components**

System component	Maintenance required	Maintenance interval
VOC sensor	Replace PID cell	5 years
Display module (See note)	Replace display	6 years
Carbon dioxide sensor (See note)	Replace sensor	6 years



**NOTE: ACG+ TO BE RETURNED TO ANALOX FOR REPLACEMENT OR SERVICE**

Before attempting to replace any sensors ensure that the ACG+ is switched off and the gas supply has been isolated. Using a Pozi-drive screwdriver loosen the 4 enclosure lid screws and open the lid.

### 10.3.1 Replacing the flow adaptor o-rings

- 1] Remove the flow adaptor for the sensor and remove the old o-ring.

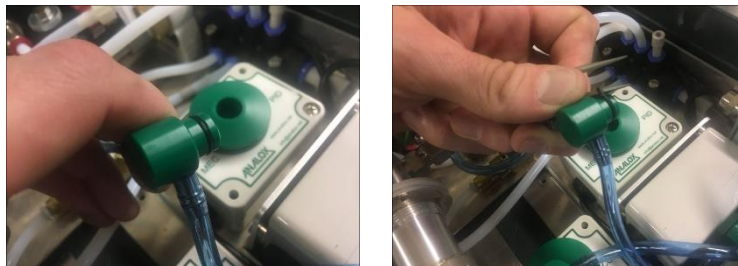

- 2] Take a new 11.1mmOD x 8.1mmID o-ring (2323-0017X) and refit to the flow adaptor, replace the flow adaptor to the sensor.



### 10.3.2 Replacing the PID cell

The following process describes how to replace the entire PID component if it is damaged or badly contaminated. The replacement part number for your sensor's PID is: **9100-2060S**.

- 1] To replace the PID component, remove the flow adaptor from the sensor inlet.

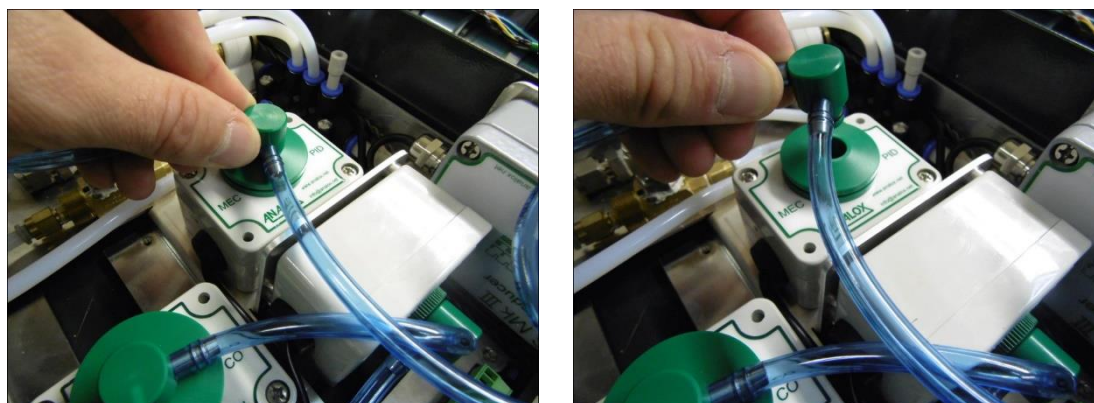

- 2] Use a flat blade screwdriver to pop out the PID holder from the sensor bulkhead fitting.



- 3] Rotate the PID PCB connector clockwise to release from the PID holder.



- 4] Disconnect the PID from the PCB connector.



- 5] Connect the new PID to the PCB connector. Note that it will only connect in one orientation.



- 6] Fit the PID in to the housing and rotate anti-clockwise to lock in place.
- 7] Refit the PID holder in to the sensor bulkhead.
- 8] Refit the flow adaptor in to the sensor inlet.



**NOTE:** FOLLOWING A VOC PID LAMP REPLACEMENT OR CLEANING, OR REPLACING THE CELL A FULL CALIBRATION MUST BE PERFORMED. SEE SECTION 5.12 FOR DETAILS.

### 10.3.2.1 Replacing the PID cell PCB (MEC-233C)

- 1] Remove the flow adaptor from the sensor inlet.

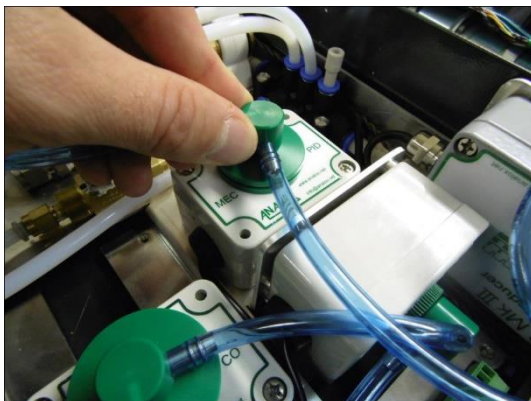

- 2] Use a terminal screwdriver to pop out the PID holder from the sensor bulkhead fitting.



**3] Rotate the PID PCB connector clockwise to release from the PID holder.**



**4] Disconnect the PID from the PCB connector.**



**5] Remove the lid from the MEC sensor housing and feed the cell PCB through the bulkhead.**

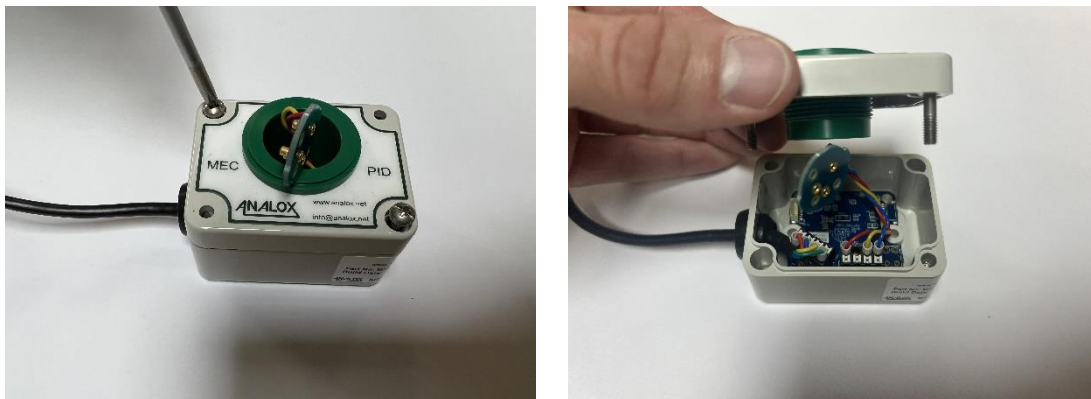



- 6] Disconnect the damaged cell PCB wiring loom from the MEC PCB connector.**

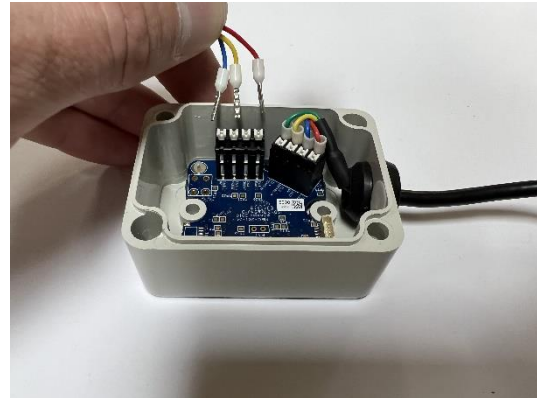
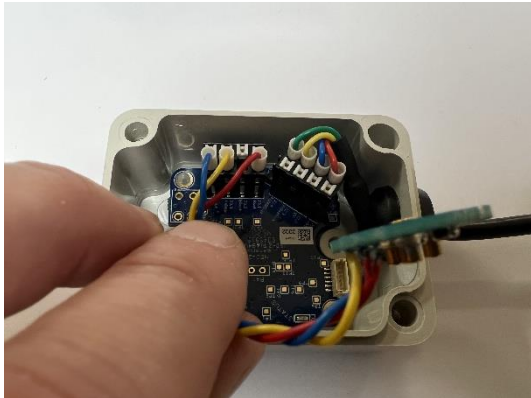

- 7] Connect the sensor wires of the new cell PCB to the corresponding red, blue and yellow terminals of connector J3.**

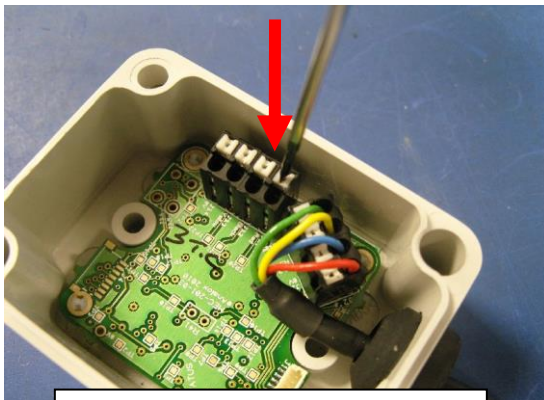

Using a terminal screwdriver press firmly down on the terminal clamp button to open the clamp.



While still pressing down on the terminal clamp button insert the bootlaced wire into the terminal clamp

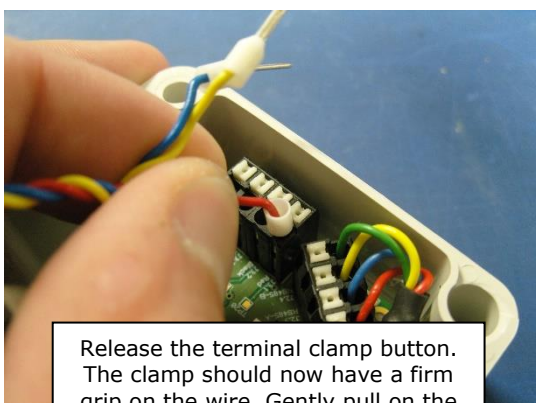

Release the terminal clamp button. The clamp should now have a firm grip on the wire. Gently pull on the wire to confirm that the wire is firmly held. If not repeat the steps shown until the wire is held firmly.

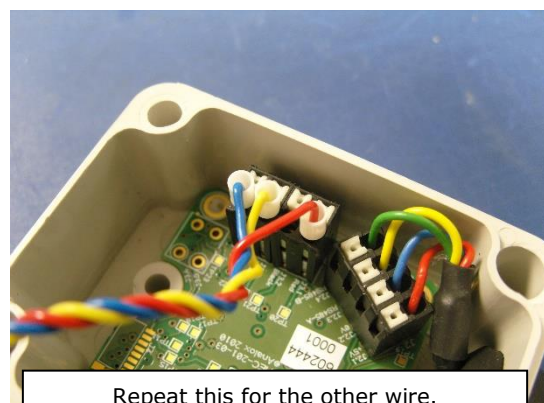

Repeat this for the other wire.

**8] Feed the PCB back through the bulkhead and refit the lid.**



**9] Connect the PID to the PCB connector PCB. Note that it will only connect in one orientation.**



**10] Fit the PID into the housing and rotate anti-clockwise to lock in place.  
11] Refit the PID holder into the sensor bulkhead.  
12] Refit the flow adaptor into the sensor inlet.**

## **11 Specifications**

Analox reserve the right to upgrade, develop or change specifications without prior notice.

### **11.1 Instrument specification**

<b>Power</b>	Input voltage: 24V DC, Power consumption: 24 W 100 to 250v AC, 50/60Hz (Optional power supply)
<b>Operating current</b>	1 Amp maximum at 24V DC
<b>Display panel</b>	320 x 240 TFT colour graphic display with 10 brightness levels.
<b>Alarm indicators</b>	Onscreen visual indication of faults and internal audible sounder
<b>Operator controls</b>	Push-button membrane
<b>Outputs</b>	Relay (NO and NC contacts) 24V DC max 3x 24V DC switch supply (500mA max total)
<b>Environmental conditions</b>	Rating: IP55 Operating temperature: -5 to +50°C (+22 to 122°F) Storage temperature: -10 to +50°C (+14 to 140°F) Ambient pressure limit: 800 to 1100 mbar Inlet pressure: 5 to 10 bar gauge (72.5 to 145 psig) Humidity: 15 to 90% RH continuous (0 to 99% RH (non-condensing) for short periods (days)) Calibration flow rate: 0.5 to 1.0 LPM
<b>Dimensions</b>	355 x 230 x 134mm (Out of carry case) 406 x 335 x 175mm (In carry case)
<b>Weights</b>	10kg (maximum – including carry case and battery pack)
<b>Sensor response (T<sub>90</sub>) for system after purge</b>	2 minutes (Sensor path) (6 minutes for H <sub>2</sub> O sensor)

## 11.2 Sensor specification

### 11.2.1 Oxygen (O<sub>2</sub>)

<b>Range</b>	0 to 50%
<b>Accuracy (over ±10°C range)</b>	±(0.035% O <sub>2</sub> + 1% of reading + Temp coefficient) Temp coefficient = 0.4% of reading/°C or 0.22% of reading/°F
<b>Detection mode</b>	Electrochemical
<b>Expected life</b>	2 years for the electrochemical cell in atmospheric air

### 11.2.2 Carbon dioxide (CO<sub>2</sub>)

<b>Range</b>	0 to 1000ppm
<b>Accuracy (over ±10°C range)</b>	±(25ppm CO <sub>2</sub> + 1% of reading + Temp coefficient) Temp coefficient = 1ppm CO <sub>2</sub> /°C or 0.56ppm CO <sub>2</sub> /°F
<b>Detection mode</b>	Infra-red
<b>Expected life</b>	6 years in operation

<b>Range</b>	0 to 10000ppm
<b>Accuracy (over ±10°C range)</b>	±(50ppm CO <sub>2</sub> + 1% of reading + Temp coefficient) Temp coefficient = 5ppm CO <sub>2</sub> /°C or 2.8ppm CO <sub>2</sub> /°F
<b>Detection mode</b>	Infra-red
<b>Expected life</b>	6 years in operation

### 11.2.3 Volatile organic compounds (VOC)

<b>Range</b>	0 to 100ppm (isobutylene equivalent)
<b>Accuracy (over ±10°C range)</b>	±(1ppm VOC + 5% of reading + Temp coefficient) Temp coefficient = 0.25% of reading/°C or 0.139% of reading/°F
<b>Detection mode</b>	Photoionisation detection (PID)
<b>Expected life</b>	Lamp - 5,000 hours (~6 months) Cell - 50,000 hours (~5 years)

### 11.2.4 Carbon monoxide (CO)

<b>Range</b>	0 to 20ppm
<b>Accuracy (over ±10°C range)</b>	±(1ppm CO + 5% of reading + Temp coefficient) 0.1ppm CO/°C + 0.5% of reading/°C or 0.056ppm CO/°F + 0.278 of reading/°F
<b>Detection mode</b>	Electrochemical
<b>Expected life</b>	2 Years in operation

### 11.2.5 Water vapour (H<sub>2</sub>O)

<b>Range</b>	0 to 100mg/m <sup>3</sup>
<b>Accuracy (over ±10°C range)</b>	±(0.15mg/m <sup>3</sup> H <sub>2</sub> O + 20% of reading)
<b>Detection mode</b>	Capacitive
<b>Service interval</b>	Replace every 2 Years

## **12 UK Declaration of Conformity**

### **UK Declaration of Conformity**

**Declaration number:** P0149-C003-00

**Manufacturer's name:** Analox Limited

**Manufacturer's address:** 15 Ellerbeck Court  
Stokesley Business Park  
Stokesley  
North Yorkshire  
TS9 5PT

**It is declared that the following product:**

**Product name:** ACG+

**Product code:** ACGPXXXXXX

**Conforms to all applicable requirements of:** IACS E10: 2006  
BS EN60945: 2002

- Complies with the Electromagnetic Compatibility Regulations 2016
- Complies with the requirements of UK RoHS 2012
- Complies with the requirements of WEEE Regulations 2013

The above product is UKCA-marked and satisfies the relevant legislative requirements of the UK



**Signed on behalf of:** Analox Limited

**Date:** 18<sup>th</sup> June 2021

**Signed:** 

**Name:** Paul Branton

**Position:** Technical Director

## 13 Declaration of conformity

### Declaration of conformity

**Declaration number:** P0149-C010-00

**Manufacturer's name:** Analox Limited

**Manufacturer's address:** 15 Ellerbeck Court  
Stokesley Business Park  
Stokesley  
North Yorkshire  
TS9 5PT

**It is declared that the following product:**

**Product name:** Analox ACG+

**Product code:** ACGPXXXXXXXX

**Product usage:** Monitoring of compressed breathing air.

**Conforms to all applicable requirements of:**  
**(when used as per the product usage)** The consolidated Environmental Compatibility requirements of IACS E10: 2006, EN 60945: 2002 and the major class society requirements.

The consolidated Electromagnetic Compatibility (EMC) requirements of IACS E10: 2006, EN 60945: 2002 and the major class society requirements.

- Complies with the requirements of the EMC Directive 2014/30/EU
- Complies with the requirements of the RoHS2 Directive 2011/65/EU
- Complies with the requirements of the WEEE Directive 2012/19/EU

CE The above product is CE-marked and satisfies the relevant legislative requirements of the European Economic Area (EEA)



**Signed on behalf of:** Analox Limited

**Date:** 3<sup>rd</sup> October 2018

**Signed:**

A handwritten signature in blue ink, appearing to read 'wml', followed by a horizontal line.

**Name:** Mark Lewis

**Position:** Managing Director