



Ax60+ Multi-Gas

User Manual



This Manual contains installation, operation & maintenance details for the Ax60+ multi-gas detector

UK Office
15 Ellerbeck Court,
Stokesley Business Park,
North Yorkshire, TS9 5PT, UK

US Office
15121 Graham Street #B106,
Huntington Beach, California,
92649

UK / Global
info@analox.biz
+44 (0)1642 711 400
+44 (0) 1642 713 900

US Office
ussales@analox.biz
(714) 891 4478
Toll Free: (877) 723 3247
(714) 891 4479

Contents

1	Safety information	5
1.1	Warnings, Cautions and Notes	5
1.2	Statement of conformity	5
1.3	Operation at altitude	5
2	Informations de sécurité	6
2.1	Déclaration de conformité	6
2.2	Fonctionnement en altitude	7
3	Signage packs	8
4	Carbon dioxide	10
5	Oxygen	11
6	Introduction	12
6.1	Ax60+ overview	12
6.2	Battery backup for the Ax60+ system	13
6.3	Hard Wired and Quick Connect options	14
7	Checklist	16
7.1	Packages, consumables and tools	16
8	Installation	18
8.1	Kiosk (K)	18
8.2	Hard Wired (HW) and Quick Connect (QC)	19
9	Connection	21
9.1	Kiosk (K)	21
9.2	Using only the Ax60+ Kiosk sensor	22
9.3	Quick Connect (QC)	24
9.4	Hard Wired (HW)	29
9.5	Optional accessories	35
10	Operation (Kiosk)	38
10.1	Powering on	38
10.2	Understanding alarms	38
10.3	Controls and indicators	40
11	Operation (HW & QC)	41
11.1	Central Display	41
11.2	Sensor	42
11.3	Alarm	43
11.4	Data Output Module (optional)	44
12	Software	45
12.1	Powering up	45
12.2	Central Display screen	47
12.3	Alarms	48
12.4	Faults	51
13	Configuration	52
13.1	Sensor software settings	52
14	Maintenance	53
14.1	Faults	53
14.2	Calibration	53
14.3	Cleaning	53
14.4	Protection	53
15	Specification	55
15.1	Central Display	55
15.2	CO ₂ Sensor	55

15.3	O ₂ Sensor.....	56
15.4	Alarm	56
15.5	Data Output Module (optional).....	57
15.6	CO ₂ Sensor performance	58
15.7	O ₂ Sensor performance	58
15.8	Product disposal.....	59
16	Warranty.....	60
17	Ax60+ UK Declaration of Conformity.....	61
18	Ax60+ Declaration of Conformity	62
19	Ax60+ Data Output Module Declaration of Conformity.....	63

1 Safety information

1.1 Warnings, Cautions and Notes

Warnings are used in this Manual to indicate potentially hazardous situations which could result in serious injury or death. Cautions are used in this Manual to indicate potentially hazardous situations which could result in equipment damage or loss of data. Notes are used in this Manual to indicate supplementary information that is not hazard related.

- ⚠ WARNING: READ THE SAFETY INFORMATION IN THIS MANUAL BEFORE INSTALLING OR USING THE AX60+.**
- ⚠ WARNING: DO NOT TEST THE ALARM WHEN IT IS CLOSE TO THE EARS. IT HAS A HIGH VOLUME SOUNDER WITH A SOUND LEVEL OF 88 DECIBELS AT A DISTANCE OF 3 METRES.**
- ⚠ WARNING: DO NOT TEST THE ALARM WHEN IT IS CLOSE TO THE EYES. IT HAS A HIGH VISIBILITY STROBE LIGHT WITH A LUMINOUS INTENSITY OF 100 CANDELA.**
- ⚠ WARNING: PERFORM A RISK ASSESSMENT BEFORE INSTALLING SENSORS AND ALARMS. IDENTIFY POTENTIAL SOURCES OF LEAKS AND AREAS OF HUMAN OCCUPATION. DO NOT USE A SINGLE SENSOR TO COVER MORE THAN 80M³. USE ADDITIONAL SENSORS IF AN AREA HAS A COMPLEX SHAPE, PHYSICAL OBSTACLES, POOR VENTILATION OR ZONES WHERE CO₂ MAY COLLECT.**
- ⚠ WARNING: INSTALL CO₂ SENSORS AT A HEIGHT OF 12" (305MM) TO 18" (457MM) ABOVE FLOOR LEVEL. THIS IS BECAUSE CO₂ IS HEAVIER THAN AIR AND MAY COLLECT AT A LOW LEVEL.**
- ⚠ WARNING: INSTALL O₂ SENSORS AT AVERAGE WORKING HEAD HEIGHT**
- ⚠ WARNING: DO NOT OPEN THE CENTRAL DISPLAY, SENSOR OR ALARM IF THEY ARE CONNECTED TO THE POWER SUPPLY. FIRST DISCONNECT AND ISOLATE THEM FROM LIVE HAZARDOUS VOLTAGE.**

1.2 Statement of conformity

It is hereby certified that the product detailed above has been inspected, tested and unless otherwise stated, conforms in all respects to our published specification.

Every Ax60+ is tested using gas applicable to the device alarm levels ensuring all alarms trigger correctly and the devices operate within the specified tolerance. Also tested are sounders, lamps, strobe functionality and that relays energise and de-energise as expected.

1.3 Operation at altitude

The toxic effects of CO₂ are dependent on the partial pressure, or the quantity of gas molecules, not the percentage in the atmosphere; therefore at altitudes above 900 metres (3000 feet) alarms will operate below the factory calibration point. Please refer to our website www.analox.net for details of suitable alarm setpoints and calibration procedures at altitude. Note that this must be performed by an authorised engineer.

- 📄 NOTE: THE SYSTEM IS SAFE AT ALTITUDE WITH FACTORY CALIBRATION, HOWEVER IF CONFORMITY MUST BE SHOWN TO A REGULATION QUOTING PERCENTAGE IN THE ATMOSPHERE THIS CAN BE ACHIEVED BY PERFORMING A LOCAL CALIBRATION.**

2 Informations de sécurité

Avertissements, mises en garde et notes

Dans ce manuel, les avertissements sont utilisés pour indiquer les situations potentiellement dangereuses pouvant entraîner des blessures graves voire mortelles. Les mises en garde de ce manuel sont utilisées pour indiquer des situations potentiellement dangereuses pouvant endommager le matériel ou engendrer la perte de données. Les notes de ce manuel indiquent des informations supplémentaires n'impliquant aucun danger particulier.

- ⚠ AVERTISSEMENT: LIRE LES INFORMATIONS DE SÉCURITÉ CONTENUES DANS CE MANUEL AVANT D'INSTALLER OU D'UTILISER AX60+.**
- ⚠ AVERTISSEMENT: NE PAS TESTER LE DÉTECTEUR À PROXIMITÉ DES OREILLES CAR IL POSSÈDE UN ÉMETTEUR TRÈS PUISSANT AVEC UN NIVEAU SONORE DE 88 DÉCIBELS À UNE DISTANCE DE 3 MÈTRES.**
- ⚠ AVERTISSEMENT: NE PAS TESTER LE DÉTECTEUR À PROXIMITÉ DES YEUX CAR IL POSSÈDE UNE LUMIÈRE STROBOSCOPIQUE AVEC UNE INTENSITÉ LUMINEUSE DE 100 CANDELAS.**
- ⚠ AVERTISSEMENT: EFFECTUER UNE ÉVALUATION DES RISQUES AVANT D'INSTALLER LES CAPTEURS ET LE DÉTECTEUR. IDENTIFIER LES SOURCES POTENTIELLES DE FUITES ET LES ZONES D'OCCUPATION HUMAINE. NE PAS UTILISER UN SEUL CAPTEUR POUR COUVRIR UNE SURFACE DE PLUS DE 80 M³. UTILISER DES CAPTEURS SUPPLÉMENTAIRES SI UNE ZONE PRÉSENTE UNE FORME COMPLEXE, DES OBSTACLES PHYSIQUES, UNE VENTILATION DE MAUVAISE QUALITÉ OU DES ZONES OÙ LE CO₂ POURRAIT S'ACCUMULER.**
- ⚠ AVERTISSEMENT: INSTALLER DES CAPTEURS DE CO₂ À UNE HAUTEUR COMPRISE ENTRE 30,5 CM À 45,7 CM AU-DESSUS DU SOL, CAR LE CO₂ EST PLUS LOURD QUE L'AIR ET PEUT S'ACCUMULER PRÈS DU SOL.**
- ⚠ AVERTISSEMENT: INSTALLER LES CAPTEURS O₂ À LA TAILLE MOYENNE DE LA TÊTE DE TRAVAIL**
- ⚠ AVERTISSEMENT: NE PAS OUVRIR L'ÉCRAN CENTRAL, LE CAPTEUR DE OU LE DÉTECTEUR DE S'ILS SONT CONNECTÉS À UNE SOURCE D'ALIMENTATION. COMMENCER PAR LES DÉBRANCHER ET LES ISOLER DES DANGERS DES COMPOSANTS SOUS-TENSION.**

2.1 Déclaration de conformité

Il est certifié par la présente que le produit décrit ci-dessus a été inspecté, testé et sauf indication contraire, est conforme en tous points à nos spécifications publiées.

Chaque Ax60 + est testé à l'aide de gaz applicable à l'alarme du dispositif niveaux assurant que toutes les alarmes déclenchent correctement et les dispositifs fonctionnent dans la tolérance spécifiée.

Également mis à l'essai sont sirènes, lampes, fonctionnalité de stroboscope et que relais mettre sous tension et hors tension comme prévu.

2.2 Fonctionnement en altitude

Les effets toxiques du CO₂ dépendent de la pression partielle, ou de la quantité de molécules de gaz, et non du pourcentage dans l'atmosphère; Par conséquent, à des altitudes supérieures à 900 mètres (3000 pieds), les alarmes fonctionneront en dessous du point d'étalonnage usine. Veuillez consulter notre site Web www.analox.net pour plus de détails sur les consignes d'alarme et les procédures d'étalonnage en altitude. Notez que cela doit être effectué par un ingénieur autorisé.

⚠ REMARQUE: LE SYSTÈME EST SÛRE À L'ALTITUDE AVEC CALIBRAGE D'USINE, CEPENDANT SI LA CONFORMITE DOIT ETRE PRESENTÉE DANS UN REGLEMENT QUOTE POURCENTAGE DANS L'ATMOSPHÈRE CELA PEUT ÊTRE ATTEINT PAR EXÉCUTION D'UNE CALIBRATION LOCALE.

3 Signage packs

NOTE: **SIGNAGE PACKS CAN BE PURCHASED FROM ANALOX, CONTACT ANALOX FOR MORE DETAILS, ALTERNATIVELY THEY CAN BE DOWNLOADED FROM [HTTPS://WWW.ANALOXSENORTECHNOLOGY.COM/](https://www.analoxsensortechnology.com/)**

The following are some examples of the CO₂ signage available in the signage packs, other signage packs for other gases are also available, signage packs will be available through Analex and if not available in your chosen language they can be created ready for purchase.

WARNING

CO₂ ALARM

STROBE / HORN	ACTIONS
CO₂ PRE-WARNING SLOW BEEP/STROBE FLASHING 	1. Ventilate - Open Exterior Door 2. Go to Ax60+ Central Display: a. Press Green ACCEPT/TEST button to mute horn. b. Follow directions on <i>What to Do</i> sign for AL1 5,000 PPM or AL2 15,000 PPM.
CO₂ DANGER ALERT FAST BEEP/ALL STROBES FLASHING 	IMMEDIATELY LEAVE OR DO NOT ENTER THE RISK ZONE. LEAVE EXTERIOR DOORS OPEN (IF POSSIBLE). CALL CO ₂ SERVICE PROVIDER FROM OUTSIDE THE RISK AREA.
LATCHED ALARM STROBES FLASHING/NO HORN	Go to Central Display. Press & hold the Green ACCEPT/TEST to release alarm.

For service contact:

ANALOX P0159-4462-00

AVISO

ALARMA DE CO₂

LUZ ESTROBOSCOPICA / CUERNA	QUE HACER
PRE-ADVERTENCIA DE CO₂ SONIDO LENTO / PARPADEO LENTO 	1. Ventilar - abrir la puerta exterior 2. Vaya a Ax60 + Pantalla central: a. Presione el botón verde ACCEPT/TEST para silenciar la bocina. b. Siga las instrucciones en el letrero <i>Qué hacer para AL1 5,000 PPM o AL2 15,000 PPM.</i>
ALERTA DE PELIGRO DE CO₂ BEEP RÁPIDO / TODOS LOS STROBES INTERMITENTES 	DEJAR INMEDIATAMENTE O NO ENTRE A LA ZONA DE RIESGO. DEJE LAS PUERTAS EXTERIORES ABIERTAS (SI ES POSIBLE). LLAME AL PROVEEDOR DE SERVICIO DE CO ₂ DESDE FUERA DEL ÁREA DE RIESGO.
ALARMA ENGANCHADA STROBES PARPADEANDO / SIN CUERNO	Vaya a la pantalla central. Mantenga presionado el botón verde ACCEPT/TEST para liberar la alarma.

Para servicio contacta:

ANALOX P0159-4462[ES00]-00

Label 1 (above left) US English; (below left) UK English; (above right) US Spanish

WARNING

CO₂ Alarm

If siren sounds AND light flashes:

1. Evacuate building immediately
2. Notify management

If light ONLY is flashing:

1. Ventilate and leave area
2. Notify management

ANALOX P0148-413-00

Label 1 should be wall mounted adjacent to the Alarm.

Label 2 (below) UK English, This label should be wall mounted outside the alarmed area.

WARNING

CARBON DIOXIDE GAS

DO NOT ENTER IF SIREN IS SOUNDING AND LIGHT IS FLASHING

A high carbon dioxide (CO₂) gas concentration in this area can cause suffocation.

ANALOX P0148-404-02

Again, an example label below, this label should be located next to the Central Unit and describes detailed CO₂ alarm response procedures in UK English. Sensor locations and emergency telephone numbers must be added by the end user.

AX60+ Safety System

WHAT TO DO IN CASE OF ALARM

PRESS THE ACCEPT/TEST BUTTON TO SILENCE ALARMS, IF IT IS SAFE TO DO SO CHECK THE TABLE BELOW TO DETERMINE THE COURSE OF ACTION

DISPLAY (CO ₂)	ACTION	DISPLAY (O ₂)
*TWA OK --- --- CO ₂ 5000 PPM	Open exterior doors and windows to ventilate the area Look for the leak and remedy. The TWA alarm will clear when the average CO ₂ levels are under 5000PPM over an 8 hour period If TWA does not resolve in a 24 hour period, contact service at _____	AL1 Disabled O ₂
OK *AL1 --- --- CO ₂ 5000 PPM	Open exterior doors and windows to ventilate the area Look for the leak and remedy If the reading does not remain under 5000 PPM for CO ₂ or above 19.5% for O ₂ , call service at _____ To release the flashing strobe, press and hold the green Accept/Test until it beeps back 1 time	OK *AL2 --- --- O ₂ 19.5 %
*AL2 OK --- --- CO ₂ 15000 PPM	Open exterior doors and windows to ventilate the area Shut off the gas supply Look for the leak and remedy If the reading does not remain under 15000 PPM for CO ₂ or below 23% for O ₂ maintain ventilation and call service at _____ To release the flashing strobe, press and hold the green Accept/Test until it beeps back 1 time	*AL3 OK --- --- O ₂ 23 %
OK *AL3 --- --- CO ₂ 30000 PPM	IMMEDIATELY LEAVE OR DO NO ENTER THE RISK ZONE. LEAVE EXTERIOR DOORS OPEN FOR VENTILATION CALL CO₂/O₂ SERVICE PROVIDER FROM OUTSIDE THE RISK AREA. Call service at _____	OK *AL4 --- --- O ₂ 18 %
*FLT FLT --- --- SNR 1 COMMS FLT	Call service at _____	

Installer: Complete these boxes before attaching this sign next to the Central Display

Sensor ID	Gas Type	Location
1		
2		
3		
4		

System Test
Hold Accept/Test button until 'TESTING ALARM' appears.
All alarms should flash & sound for 5 seconds.

PD159-4255-04

www.analox.net

Label 3: This label should be wall-mounted adjacent to the Central Display

4 Carbon dioxide

1,000ppm (0.1%)
5,000ppm (0.5%)
10,000ppm (1%)
15,000ppm (1.5%)
20,000ppm (2%)
30,000ppm (3%)
40,000- 50,000ppm (4-5%)
50,000- 100,000ppm (5-10%)
100,000- 1,000,000ppm (10-100%)

- 1–1.5% Slight effect on chemical metabolism after exposures of several hours.
- 3% The gas is weakly narcotic at this level, giving rise to deeper breathing, reduced hearing ability, coupled with headache, an increase in blood pressure and pulse rate.
- 4–5% Stimulation of the respiratory centre occurs resulting in deeper and more rapid breathing. Signs of intoxication will become more evident after 30 minutes' exposure.
- 5–10% Breathing becomes more laborious with headache and loss of judgement.
- 10–100% When the CO₂ concentration increases above 10%, unconsciousness will occur in less than one minute. Unless prompt action is taken, further exposure to these high levels will eventually result in death.

Adapted from: 'Carbon Dioxide Physiological Hazards', Safety Info 24/11/E, European Industrial Gases Association.



5 Oxygen

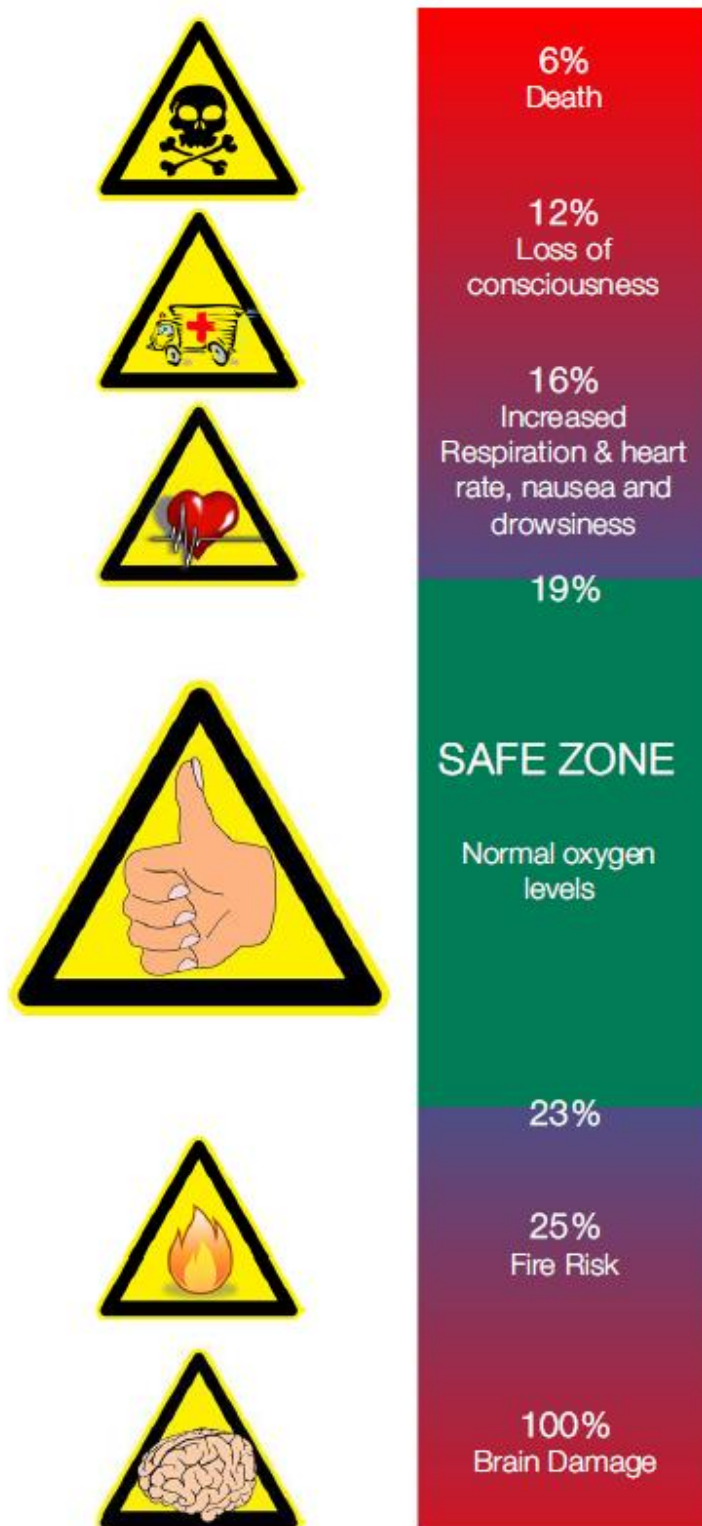

6 Introduction

This User Manual explains how to install, operate and maintain the Ax60+. It is intended for system installers and end users. For information on servicing, refer to the *Ax60+ Service Manual P0159-803*, available from the [Analox Sensor Technology Ltd website](#).

6.1 Ax60+ overview

The Ax60+ is a life-safety device that monitors the amount of atmospheric gases in ambient air. The Ax60+ multi-gas detector is available with different sensors for different gases. Gases such as oxygen and carbon dioxide are essential components of the air we breathe, but any deviation from their natural levels is potentially dangerous. Some industrial equipment and processes use concentrated forms of atmospheric gases which can present a serious health risk to anyone visiting or working in the vicinity.

6.1.1 Carbon dioxide sensors

The Ax60+ CO₂ sensor offers protection for people working in the proximity of high-concentration sources of carbon dioxide such as pressurised gas bottles or dry ice. These are typically used in beverage delivery, food production, fire suppression systems and laboratories.

The potentially lethal effects of CO₂ are compounded by its physical properties—it is a colourless, odourless gas—and it has been known to cause suffocation without warning. Therefore there is a risk to health wherever CO₂ is stored or used in an enclosed area.

6.1.2 Oxygen sensors

The Ax60+ offers an oxygen (O₂) sensor for use in areas where the level of atmospheric oxygen may be influenced by an industrial process. In places where high concentrations of oxygen are stored in pressurised containers, any leak could lead to an increase in the O₂ level in the surrounding air. This O₂ enrichment greatly increases the risk of fire.

In places where an inert gas such as nitrogen (N₂) is used, a gas leak could result in oxygen depletion of the local environment. This is potentially hazardous to health. The Ax60+ O₂ sensor monitors for both high and low levels of O₂ and warns of any changes.

6.1.3 Data Output Module (optional)

The Ax60+ offering includes an optional Data Output Module that can be used to interface into a building management system providing live readings via MODBUS RTU or 4 independent 4-20mA current loop signals. (See section 15.5 for further details)

6.1.4 CO₂ Zero and positive drift compensation

Zero: The sensor unit monitors for negative sensor drift every hour and compensates for the negative reading up to a maximum limit of (default of -3000 PPM). A fault condition is raised when the maximum limit has been exceeded. The fault condition is cleared by attempting a manual zero calibration.

Positive drift: The sensor unit continuously monitors for positive drift over a rolling period of 30 days. If the reading is continuously above 733 PPM then the sensor unit will compensate the reading. If compensation exceeds a maximum limit (default of 3000 PPM) then a fault condition is raised. The fault condition is cleared by attempting a manual span calibration.

6.2 Battery backup for the Ax60+ system

If the Ax60 is required to operate in the event of a power outage a battery backup unit can be connected in place of the AC/DC power adapter providing the following conditions are met:

1. The supply is a limited energy supply in accordance with IEC 61010-1:2010 clause 9
2. The supply shall provide double insulation or reinforced insulation according to IEC 61010-1:2010
3. Output voltage of 24V nominal
4. Current rating of 1A
5. 2x 7Ah batteries for 24hr standby time.

Analox would recommend using an EN54-4 approved supply like an Elmdene STX2401-C or equivalent paired with a set of Yuasa NP7-12 batteries. This unit will provide 24 hours of standby time under normal operating conditions.

Link to the Elmdene website: <https://www.elmdene.co.uk/>

Search for the STX range of battery backups.

The STX2401-C user manual can be found here:

<https://www.analoxsensortechnology.com/downloads/STX2401UserManual.pdf>

6.2.1 Connection to Ax60+ system

The AC/DC power supply can be discarded or if required the wires can be removed and used to connect the battery backup unit to the Ax60+ Central Unit. See drawing below:

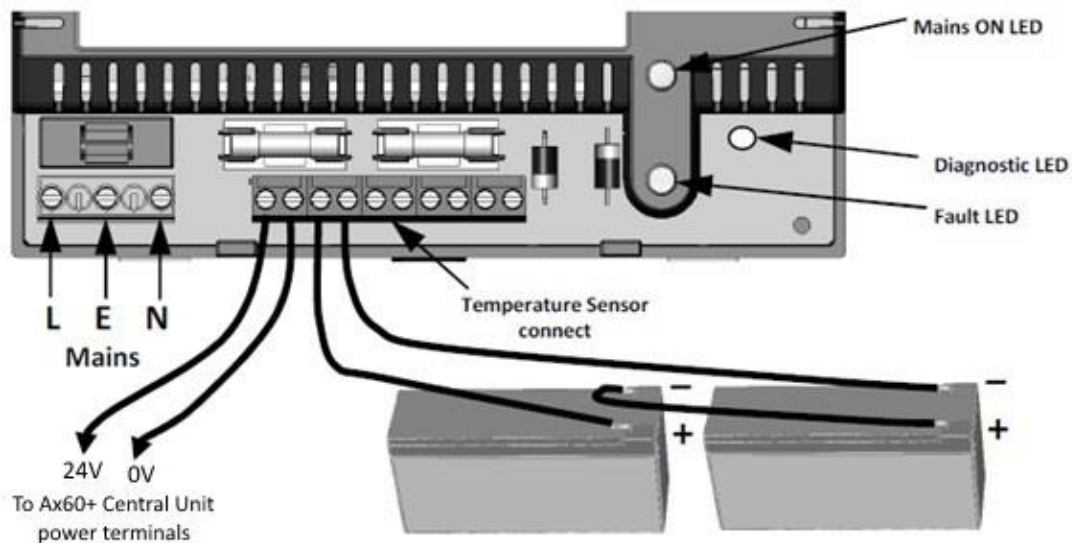

Please follow manufacturer's instructions when installing the battery backup unit.

6.3 Hard Wired and Quick Connect options

The Ax60+ is available as either a **Hard Wired** or a **Quick Connect** option. This choice must be made when placing the order. Hard Wired systems are intended to be integrated with the building fabric. Quick Connect systems are pre-wired with Cat5e cables fitted with colour-coded RJ45 connectors for an easier installation. Both options require installers to connect the power supply unit and optional beacon to the Central Display.

The standard Ax60+ comprises one Central Display, up to four Sensors and up to eight Alarms. An optional high-visibility flashing beacon can also be connected for remote installation up to 50 metres away. This beacon acts as a highly visible but silent repeater, and is illuminated when any Sensor triggers an alarm.

In addition, two relays are available on the Central Display for connection to an external system such as a fire alarm panel or a ventilation fan (via an external mains relay).

6.3.1 Typical arrangement

The Central Display is usually installed in a central location (e.g. a Manager's office) and connected to one or more Sensors in remote areas such as store rooms or corridors. The Sensors send alarm signals to one or more Alarm units in locations where they can be observed by management or crew. The Central Display monitors the Sensors and displays their current measurements. The example below shows a system incorporating a Central Display, two CO₂ sensors, two O₂ sensors, eight alarms and a beacon.

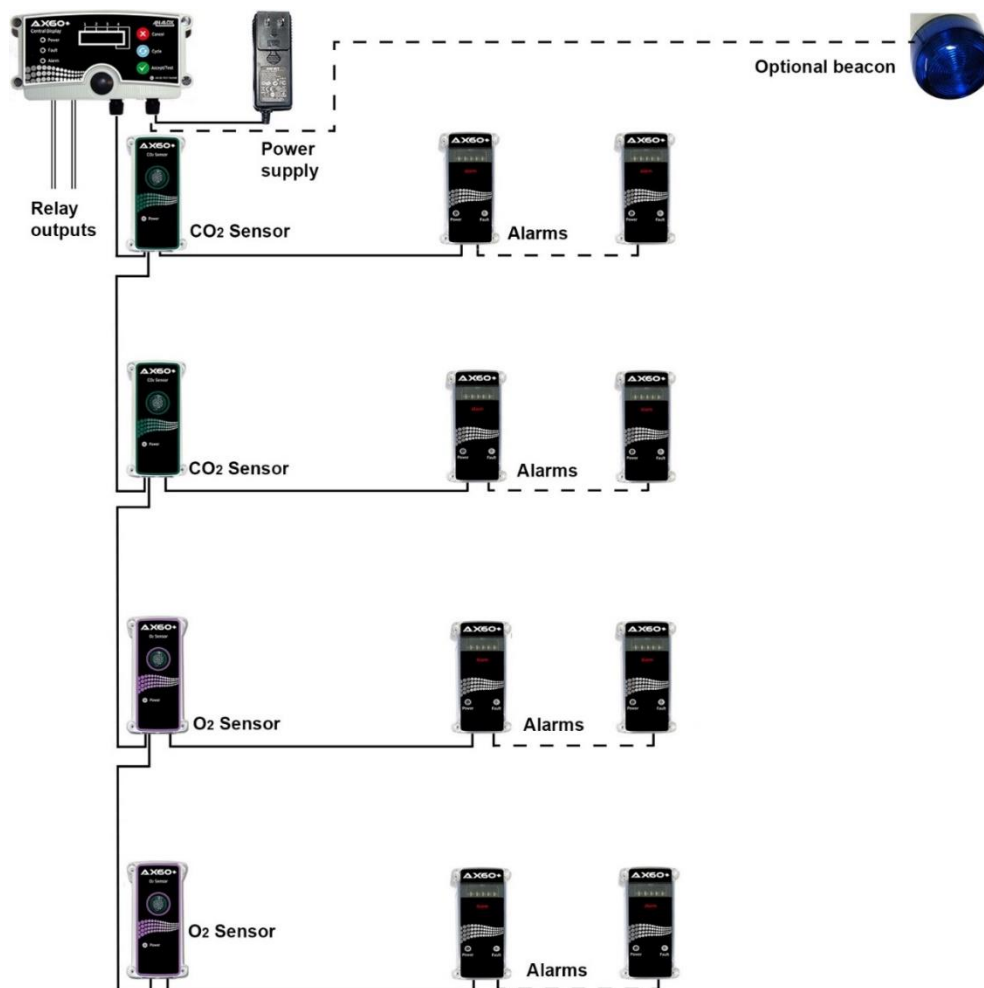

6.3.2 Kiosk option

A compact version of the Ax60+, the Ax60K Kiosk, is available for outdoor kiosks and food-court restaurants. This incorporates a CO₂ Sensor, Alarm and power supply. The CO₂ Sensor constantly monitors the air and detects increases in the level of carbon dioxide. If it detects a level of CO₂ above set limits it sends a signal to the Alarm. The Alarm uses a high-visibility strobe light and high volume sounder to warn of increased levels of CO₂. The warnings vary depending on the amount of CO₂ detected.

All alarms on the Ax60+ Kiosk variant are unlatched by default, which means, when an alarm occurs, the unit will go into alarm as normal. When the gas level returns to normal any active alarms will automatically clear without any operator intervention.

The power supply unit (PSU) supplies 24 V DC to the CO₂ Sensor, which in turn supplies power to the CO₂ Alarm. The CO₂ Sensor and Alarm are pre-wired with 2-metre connecting cables. A cable coupler is supplied to allow the cables to be connected.

 **NOTE: THE DATA OUTPUT MODULE IS NOT COMPATIBLE WITH THE AX60+ KIOSK VARIANT.**

6.3.3 Data Output Module (DOM)

The Data Output Module (DOM) can be connected to an existing Ax60+ system to give real-time indication of any connected sensors readings via industry standard 4-20 mA outputs and/or Modbus RTU interface. The unit is completely self-contained and simply connects to the existing CAT-5 cable installation. Both 4-20 mA outputs and Modbus RTU interface can easily and quickly be connected to a compatible device / system that can provide a visual indication of measured gas levels.

The DOM continuously monitors communications between the Central Unit and connected Sensor Units. The gas level readings are converted to a scaled mA current level between 4 and 20. A current level of 4 mA indicates a 0% of scale reading and 20 mA current level indicates a 100% of scale reading.

Additionally the Modbus RTU interface can be connected to a Building Management System (BMS), or similar, giving further information on the operational state of the Ax60+ system. The DOM can be interrogated for gas levels as displayed on the Central Unit, any active alarms and faults on a Sensor Unit and the operating condition of the DOM itself.

7 Checklist

7.1 Packages, consumables and tools

Package contents (Supplied by Analox)	Ax60K Kiosk (K)
	<p>1 x CO₂ Sensor, including:</p> <ul style="list-style-type: none"> • 1 x 2m factory fitted Quick Connect (QC) cable with blue RJ45 connector • 1 x mains power supply unit (PSU) (plug-in type complete with UK, US, Eu & Aust interchangeable heads) <p>1 x Alarm (additional Alarms can be ordered) including:</p> <ul style="list-style-type: none"> • 1 x 2m factory fitted QC cable with blue RJ45 connector • 1 x PSU securing strip • 1 x RJ45 coupler for connecting the cables • 1 x Quick Start Guide & templates • 1 x Signage pack (If purchased at time of order, see section 3 for details)
Tools required (NOT SUPPLIED)	Ax60+ Quick Connect (QC)
	<p>1 x Central Display, including:</p> <ul style="list-style-type: none"> • 1 x 2m factory fitted Quick Connect (QC) cable with Grey RJ45 connector (for connection to Sensor) • 1 x power supply unit (PSU), either hard-wired type or plug-in type (With UK, US, Eu & Aust interchangeable heads) depending on the package ordered • 1 x PSU securing strip (for plug-in type PSU only) <p>1 to 4 x Sensors (depending on the package ordered) each with:</p> <ul style="list-style-type: none"> • 1 x 5m factory fitted QC cable with Grey RJ45 connector (for connection to the Central Display or another Sensor) • 1 x 5m factory fitted QC cable with blue RJ45 connector (for connection to Alarm) <p>1 to 8 x Alarms (depending on the package ordered) each with:</p> <ul style="list-style-type: none"> • 1 x 5m factory fitted QC cable with blue RJ45 connector (for connection to Sensor) <p>1 x Quick Start Guide & templates Selection of RJ45 couplers and RJ45 splitters (As applicable)</p> <ul style="list-style-type: none"> • 1 x M13 cable gland (for relay connection) • 1 x high-visibility optional beacon (if ordered) • 1 x Signage pack (If purchased at time of order, see section 3 for details) • 1x Data Output Module (if ordered)
Tools required (NOT SUPPLIED)	<p>PZ1 Pozi screwdriver; drill and drill bits for wall plugs; spirit level; tape measure.</p>

<p>Package contents (supplied by Analox)</p>	<p>Ax60+ Hard Wired (HW)</p> <p>1 x Central Display, including:</p> <ul style="list-style-type: none"> • 1 x power supply unit (PSU), either hard-wired type or plug-in type (With UK, US, Eu & Aust interchangeable heads) depending on the package ordered • 1 x PSU securing strip (for plug-in type PSU only) • Self-adhesive foam gasket for use in rear-entry cable installations <p>1 to 4 x Sensors (depending on the package ordered) each with:</p> <ul style="list-style-type: none"> • Self-adhesive foam gasket for use in rear-entry cable installations 📁 NOTE: US IFC CONFIGURED SENSORS ARE SUPPLIED WITH CAT5E CABLE <p>1 to 8 x Alarms (depending on the package ordered)</p> <ul style="list-style-type: none"> • Self-adhesive foam gasket for use in rear-entry cable installations 📁 NOTE: US IFC CONFIGURED ALARMS ARE SUPPLIED WITH CAT5E CABLE <p>1 x Quick Start Guide & templates</p> <ul style="list-style-type: none"> • 1 x M13 cable gland (for relay connection) • 1 x high-visibility optional beacon (if ordered) • 1 x Signage pack (If purchased at time of order, see section 3 for details) • 1x Data Output Module (if ordered)
<p>Consumables (depending on package)</p>	<p>M13 cable glands 5—7mm (nylon), quantity to suit installation</p> <p>Wall plugs and screws (fixing kits), quantity to suit installation</p>
<p>Tools required (NOT SUPPLIED)</p>	<p>PZ1 Pozi screwdriver; 3mm flat blade screwdriver</p> <p>Cat5e cable jacket stripper; 24AWG wire stripper</p> <p>Drill and drill bits for wall plugs; spirit level, tape measure, ruler</p> <p>Small hammer, centre punch and pliers for removing knockouts</p>

8 Installation

NOTE: WHEN THE INSTALLATION IS COMPLETE, FIX THE HAZARD WARNING/INFORMATION SIGNAGE (IF SUPPLIED) ON THE APPROPRIATE WALLS AND ENSURE THE LABELS ARE READ AND UNDERSTOOD BY ALL STAFF.

8.1 Kiosk (K)

8.1.1 CO₂ Sensor

Retain the clear protective film on the fascia until the installation is complete. Using the supplied paper template mark out the wall-fixing position for the CO₂ Sensor ensuring it is level. Drill holes in wall, install plugs/ dowels then fix the CO₂ Sensor in position.

WARNING: CARBON DIOXIDE GAS (CO₂) IS HEAVIER THAN AIR AND SHOULD BE MONITORED FROM A LOW HEIGHT. YOU SHOULD THEREFORE INSTALL THE CO₂ SENSOR AT A HEIGHT OF 12-18" (305-457MM) ABOVE THE FLOOR LEVEL.



8.1.2 Alarm

WARNING: SOME KIOSKS AND FOOD COURT RESTAURANTS MAY BE EXPOSED TO HIGH-VOLUME BACKGROUND NOISE. INSTALL THE ALARM SO THAT IT IS AUDIBLE & VISIBLE FROM ALL ACCESS AND EGRESS POINTS AND BUSY AREAS.

Retain the clear protective film on the fascia until the installation is complete. Using the supplied paper template mark out the wall-fixing position for the Alarm ensuring it is level. Drill holes in wall, install plugs/ dowels then fix the Alarm in position.



8.1.3 Cables

Route the pre-wired cables from the CO₂ Sensor and Alarm securely along the wall. Fit the cable coupler then connect the cables together. Then route the pre-wired cable from the PSU securely along the wall.



8.1.4 Power supply

Fit the appropriate interchangeable plug head for your power socket. Ensure the power supply is off. Insert the plug into the power socket.

Mark out the wall-fixing position for the PSU securing strip. Drill holes in the wall and install wall plugs/dowels. Fix the securing strip firmly over the PSU.



8.2 Hard Wired (HW) and Quick Connect (QC)

CAUTION: SOME ENCLOSURES ARE SUPPLIED UNFASTENED WITH FIXING SCREWS LOOSE. DO NOT OVER-TIGHTEN THE SCREWS WHEN FASTENING THE LIDS ON.

8.2.1 Central Display

Using the supplied paper template mark out the wall-fixing position ensuring the Central Display is level. If you are installing cable through the rear of the enclosure, remove the knockout then fit a foam gasket over its aperture to provide a seal against ingress.

CAUTION: TO PREVENT DAMAGE TO THE FASCIA AND PRINTED CIRCUIT BOARD (PCB), REMOVE THEM FROM THE ENCLOSURE BEFORE REMOVING KNOCKOUT.

Drill holes in the wall then fit wall plugs/dowels. Fasten the lid of the enclosure to the base then fix the Central Display in position. Install the cables in position and cut them to length (HW).

Removing the knockout (Optional for HW systems)

To remove the knockout, place the enclosure face down on a solid, non-slip surface. Tap the knockout firmly using a hammer and punch. Use pliers to remove sharp edges from the aperture.

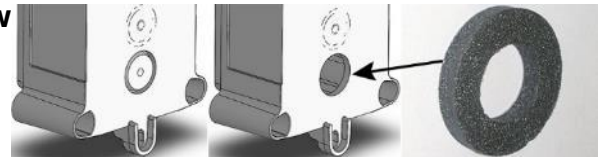

8.2.2 Sensor

Using the supplied paper template mark out the wall-fixing position ensuring the Sensor is level. (If installing a cable through the rear, remove the knockout.)

WARNING: CARBON DIOXIDE GAS (CO₂) IS HEAVIER THAN AIR AND SHOULD BE MONITORED FROM A LOW HEIGHT. YOU SHOULD THEREFORE INSTALL THE CO₂ SENSOR AT A HEIGHT OF 12–18" (305–457MM) ABOVE THE FLOOR LEVEL.

WARNING: O₂ SENSORS SHOULD BE INSTALLED AT AVERAGE WORKING HEAD HEIGHT

Drill holes in wall, install wall plugs/dowels then fit the Sensor. Install the cables in position and cut them to length (HW).



8.2.3 Alarm

⚠ WARNING: LOCATE THE ALARM SO AS TO PROVIDE COVERAGE FOR ACCESS AND EGRESS POINTS AND BUSY AREAS.

Using the supplied paper template mark out the wall-fixing position ensuring the Alarm is level. (If installing a cable through the rear, remove the knockout.)

Drill holes in wall, install wall plugs/dowels then fit the Sensor. Install the cables in position and cut them to length (HW).



8.2.4 Data Output Module (optional)

📁 NOTE: ANALOX RECOMMEND MOUNTING THE DATA OUTPUT MODULE NEXT TO THE CENTRAL DISPLAY

Using the supplied paper template mark out the wall-fixing position ensuring the Data Output Module is level. (If installing a cable through the rear, remove the knockout.)

Drill holes in wall, install wall plugs/dowels then fit the Data Output Module. Install the cables in position and cut them to length (HW).



9 Connection

9.1 Kiosk (K)

The Ax60K Kiosk option is pre-wired with Cat5e cables and colour-coded RJ45 connectors to allow easy connection.

NOTE: **PRIOR TO CONNECTING THE RJ45 CONNECTORS TO THE COUPLERS OR SPLITTERS IT IS NECESSARY TO MODIFY THEM BY BENDING THE RJ45 LOCK CLIP OUTWARDS TO 90° AND THEN REINSERTING INTO THE CONNECTOR BOOT.**

For blue booted versions, the boot does not slide away but can be pulled back to allow for the lock clip to be bent to 90°, then the boot can be pulled back over the lock clip.



Pull boot back to access lock clip

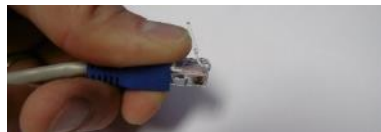

Bend lock clip to 90°



Slide boot back over lock clip

For grey booted versions (Extension cables), slide the boot back and bend the lock clip outwards to 90°, then pull the boot back over the lock clip.



Slide boot back to access lock clip



Bend lock clip to 90°



Slide boot back over lock clip

The Kiosk components are shown below.



CO₂ Sensor, pre-wired cables and PSU



Alarm, pre-wired cable and coupler

9.2 Using only the Ax60+ Kiosk sensor

- NOTE:** IF THE KIOSK SENSOR IS TO BE USED ON ITS OWN (WITHOUT AN ALARM CONNECTED) THEN THE BLUE BOOTED CAT5E CABLE AND GLAND SHOULD BE REMOVED USING THE FOLLOWING PROCEDURE.
- WARNING:** DISCONNECT AND ISOLATE THE AX60+ SYSTEM FROM THE MAINS POWER SUPPLY BEFORE OPENING THE SENSOR ENCLOSURES.

[1] Remove the front cover from the Ax60+ Kiosk Sensor enclosure.



[2] Disconnect the following wires from the 10 way screw terminal, leaving the two black wires in place (PSU).

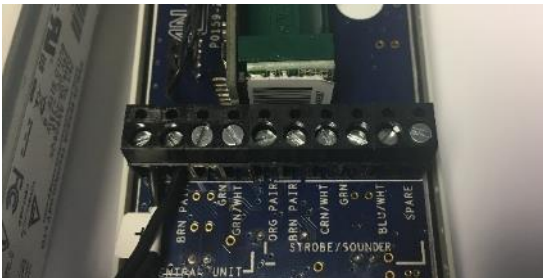

ORG PAIR (existing cable)
BRN PAIR (existing cable)
GRN/WHT (existing cable)
GRN (existing cable)
BLU/WHT (existing cable)
SPARE (not used)

[3] Loosen the cable gland lock nut and remove, then remove the gland and cable from the enclosure.



[4] Fit a gland blanking disc over the hole which the gland and cable were removed from.



[5] Reconnect the mains supply and power-up the Ax60+ Kiosk.

9.2.1 Typical layouts

The standard Ax60K Kiosk incorporates one Alarm unit (see below, left). An additional Alarm unit can be ordered to expand the system (see below, right).



1 x CO₂ Sensor; 1 x Alarm; 1 x PSU



1 x CO₂ Sensor; 2 x Alarms; 1 x PSU

9.3 Quick Connect (QC)

The Ax60+ Quick Connect option is pre-wired with Cat5e cables and colour-coded RJ45 connectors for easy connection.

NOTE: **PRIOR TO CONNECTING THE RJ45 CONNECTORS TO THE COUPLERS OR SPLITTERS IT IS NECESSARY TO MODIFY THEM BY BENDING THE RJ45 LOCK CLIP OUTWARDS TO 90° AND THEN REINSERTING INTO THE CONNECTOR BOOT.**

For grey booted versions, slide the boot back and bend the lock clip outwards to 90°, then pull the boot back over the lock clip.



Slide boot back to access lock clip



Bend lock clip to 90°



Slide boot back over lock clip

For blue booted versions, the boot does not slide away but can be pulled back to allow for the lock clip to be bent to 90°, then the boot can be pulled back over the lock clip.



Pull boot back to access lock clip

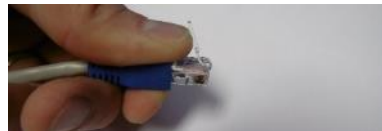

Bend lock clip to 90°



Slide boot back over lock clip

The Quick Connect components are shown below.

9.3.1 Central Display



Pre-wired cable for connection to Sensor(s)

The Quick Connect Central Display is pre-fitted with two cable glands (see left). The gland on the right has a 2-metre cable fitted with a Grey RJ45 connector for connection to a Sensor.

The empty gland on the left is for the power supply unit cable. A third gland must be fitted if the optional beacon or relays are to be utilised. Both of these cables must be fitted by the installer.

If the built-in relays R1 and R2 are being used, another knockout should be removed from the enclosure and an additional gland should be fitted for the relay cables.

9.3.2 Sensor



Pre-wired cables for connection to the Alarm (left), and to the Central Display (right)

The Quick Connect Sensor is fitted with two cable glands and is pre-wired with two cables:

- 5-metre cable with Grey RJ45 connector for connection to the Central Display
- 5-metre cable with blue RJ45 connector for connection to the Alarm(s)

The cable with the Grey RJ45 connector is connected to the Central Display via a coupler.

The cable with the blue RJ45 connector should be connected to the Alarm (which also has a blue connector) via an RJ45 coupler (or an RJ45 splitter if there is more than one Alarm).

9.3.3 Alarm



Pre-wired cable for connection to a Sensor

The Quick Connect Alarm is fitted with one cable gland and a 5-metre cable with a blue RJ45 connector. This should be connected to the Sensor which is associated with the Alarm, via an RJ45 coupler (or an RJ45 splitter if there is more than one Alarm).

9.3.4 Data Output Module (optional)



Pre-wired cable for connection to a Sensor

The Quick Connect Data Output Module is fitted with one cable gland and a 2-metre cable with a grey RJ45 connector. This should be connected in-line (via the splitter) between the first Sensor and Central Display, or between sensors.

NOTE: THE DATA OUTPUT MODULE CAN NOT BE PLACED IN-LINE WITH A SENSOR AND ALARM.

NOTE: NO WIRING IS SUPPLIED FOR THE 4-20mA OUTPUTS OR THE MODBUS INTERFACE

9.3.5 Cables and connectors

The couplers supplied with the Ax60+ Quick Connect are shown below, the splitters can be supplied as an optional accessory. These provide enough flexibility for a typical installation.

⚠ **CAUTION: ENSURE THAT THE MAXIMUM CABLE LENGTH BETWEEN THE CENTRAL DISPLAY AND THE FINAL SENSOR IS NOT MORE THAN 100 METRES.**

RJ45 coupler



The supplied RJ45 coupler (left) is used to connect two Grey RJ45 connectors. Grey RJ45 connectors are used for all *Central Display-to-Sensor* and *Sensor-to-Sensor* connections.



The same RJ45 coupler is used to connect the blue RJ45 connectors which are used for all *Sensor-to-Alarm* connections.

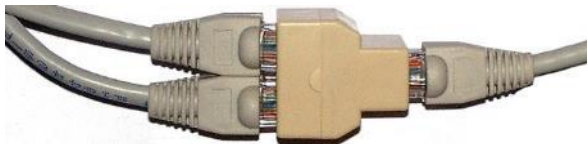

RJ45 splitter (Optional accessory)

The RJ45 splitter (left) is used to connect two Sensors or two Alarms on a common cable.

9.3.6 Typical installation Examples

In its simplest form a Quick Connect Ax60+ system could incorporate a Central Display, one Sensor and one Alarm. A larger Ax60+ system could incorporate a Central Display, four Sensors and eight Alarms. Different gas Sensors can be combined; for example, a system could include both CO₂ and O₂ Sensors and could also include a Data Output Module. Some typical layouts are shown below.

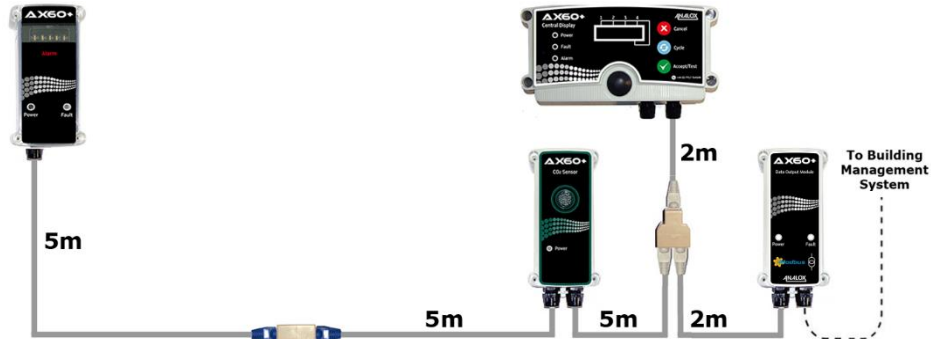

1 x Central Display; 1 x CO₂ Sensor; 1 x Alarm, 1 x Data Output Module

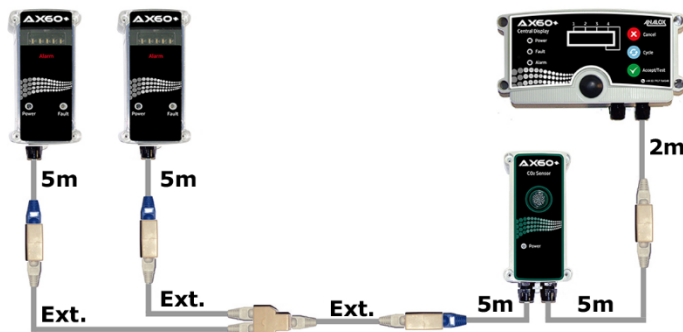

1 x Central Display; 1 x CO₂ Sensor; 2 x Alarms

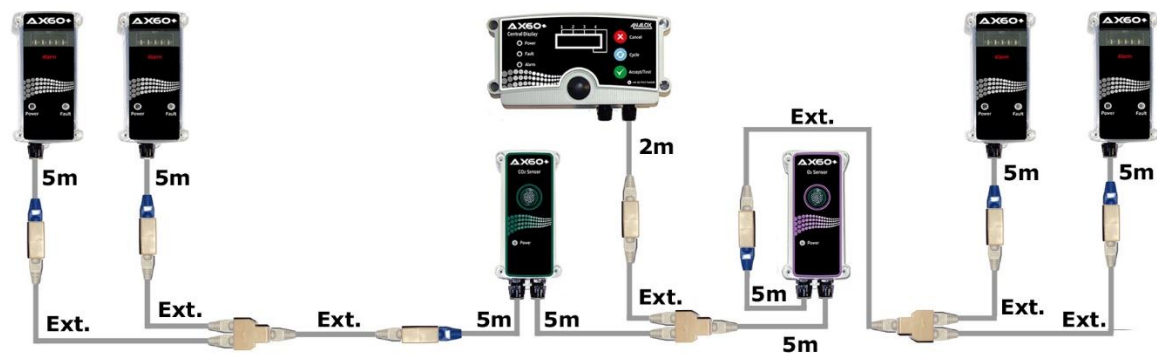

1 x Central Display; 1 x CO₂ Sensor; 1 x O₂ Sensor; 4 x Alarms

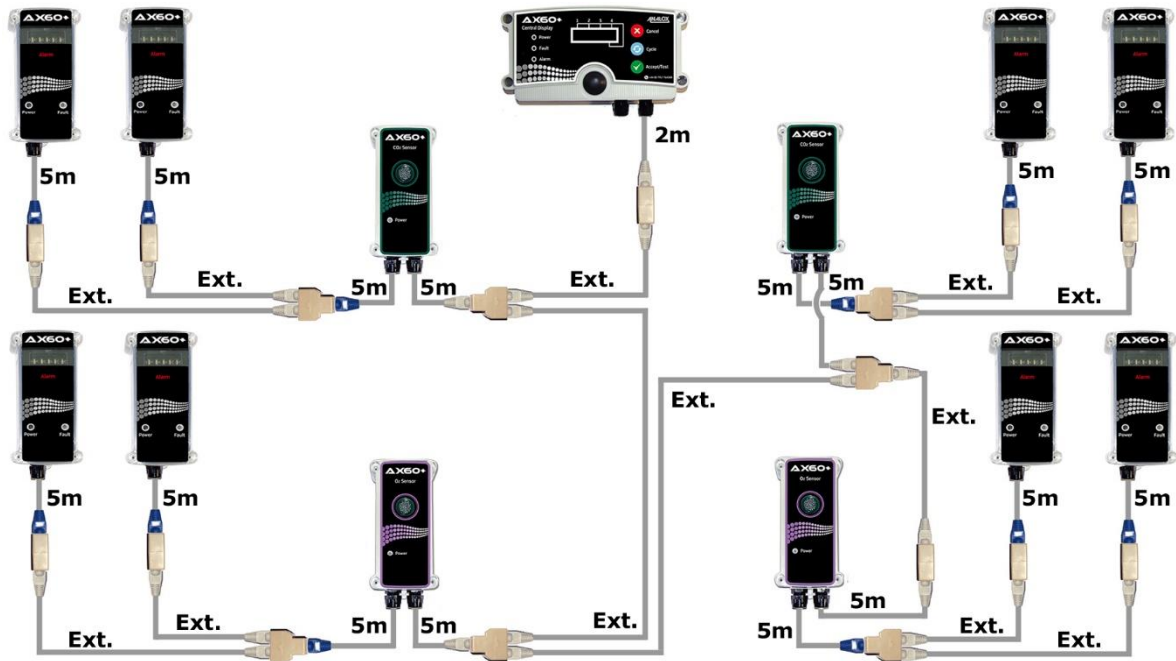

1 x Central Display; 2 x CO₂ Sensors; 2 x O₂ Sensors; 8 x Alarms

The 2 metre cable from the central unit and the 5-metre cables from the sensors and alarms shown in the previous diagrams are pre-fitted to the enclosures. The RJ45 extension cables marked **Ext.** are available as an accessory from Analox or can be sourced by the installer. The supplied RJ45 couplers and optional RJ45 splitters (Available from Analox) allow the system to be customised to suit the building. Other system layouts are possible, providing that the maximum number of Sensors (4) and Alarms (8) are not exceeded.

NOTE: FOR INFORMATION ON CONNECTING THE POWER SUPPLY UNIT, OPTIONAL BEACON AND RELAYS, REFER TO SECTION 9.4

9.4 Hard Wired (HW)

CAUTION: THE RECOMMENDED CABLE ARRANGEMENT IS THE DAISY CHAIN AS SHOWN BELOW. DO NOT USE ANY OTHER CONFIGURATION.

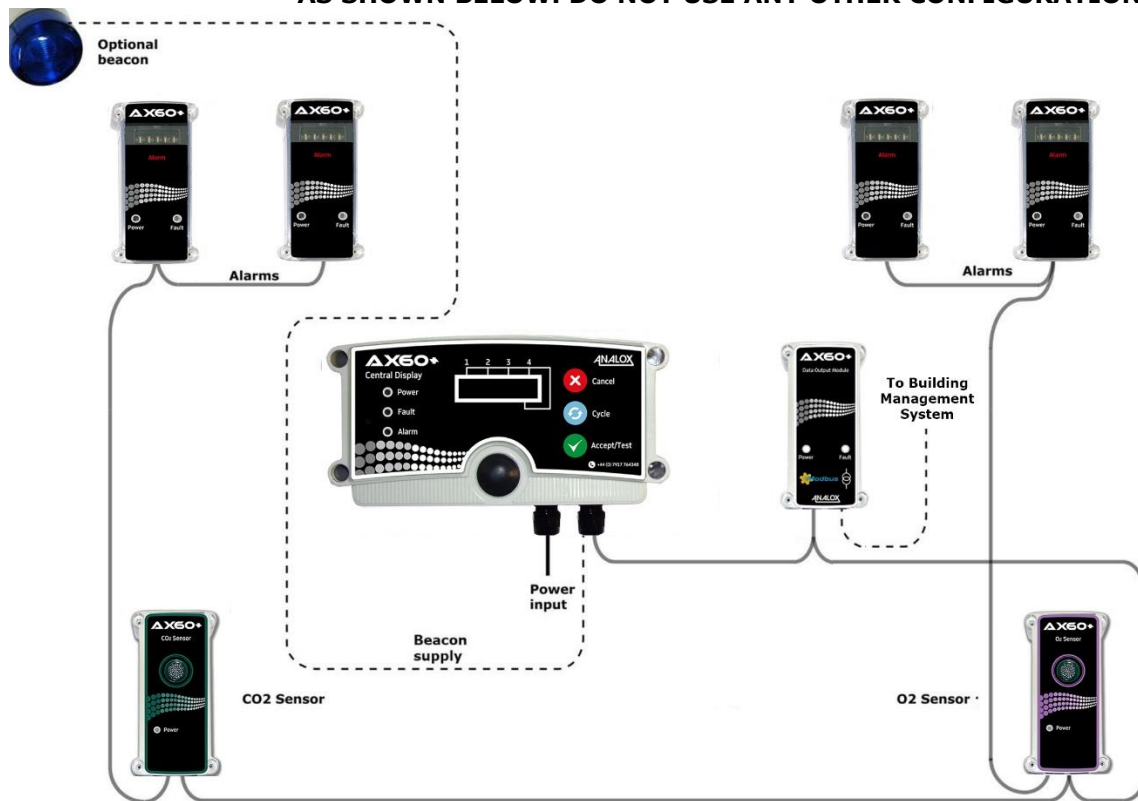

9.4.1 Cable requirements

Cable type	Wire colour	Abbreviation
Cat5e, UTP, 24AWG, PVC	Orange	ORG
	Orange and White	ORG/WHT
	Brown	BRN
	Brown and White	BRN/WHT
	Green and White	GRN/WHT
	Green	GRN
	Blue and White	BLU/WHT
	Blue	BLU

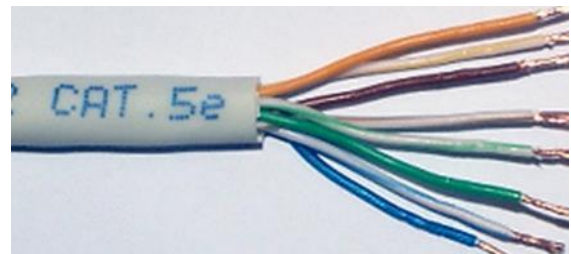

If you install cables through walls, remove the knockout and fit a foam gasket to maintain ingress protection (see below left). If you install cables along wall surfaces, fit cable glands (below right).



CAUTION: ENSURE THAT THE MAXIMUM CABLE LENGTH BETWEEN THE CENTRAL DISPLAY AND THE FINAL SENSOR IS NOT MORE THAN 100 METRES.

9.4.2 Sensors and Alarms

The recommended cable arrangement for connecting the Sensors and Alarms is shown below. For the purposes of this example the enclosures have been removed and the cables have been shortened for convenience. The Central Display is not shown. Note that the different Sensor types are interchangeable and are connected in the same way.

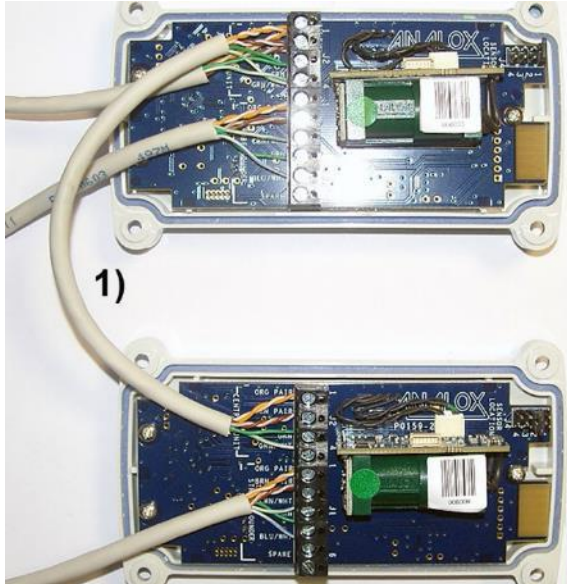

1) Sensors connected via daisy-chain

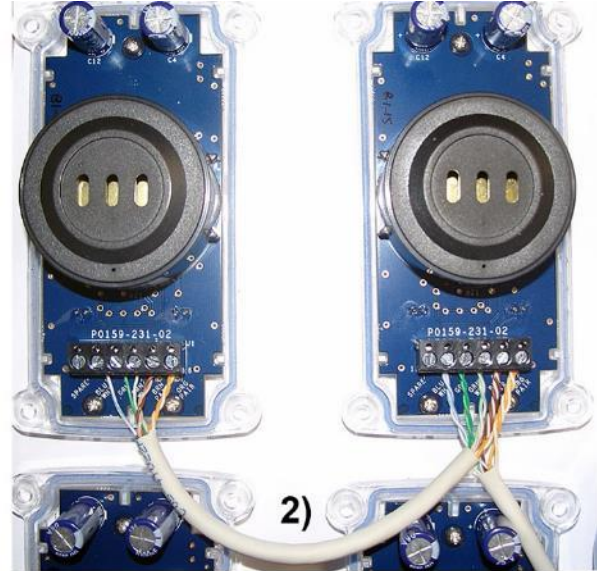

2) Alarms connected via daisy-chain

9.4.3 Central Display Terminals



Sensor	Beacon	Power	Relay 2 Relay 1
(see section 9.4.4)	(see section 9.4.6)	(see section 9.4.5)	<p>⚠ SPDT RELAYS RATED FOR 250VAC/30VDC 3A MAX (REFER TO THE P0159-803 AX60+ SERVICE MANUAL FOR FURTHER INFORMATION ON USING RELAYS)</p>

⚠ **WARNING: CABLES CONNECTED TO THE RELAY TERMINALS SHOULD HAVE A FLAMMABILITY RATING OF VW-1 OR BETTER AND BE RATED FOR TRANSIENT OVERVOLTAGES UP TO THE LEVELS OF OVERVOLTAGE CATEGORY II AS STATED IN IEC 61010-1:2010.**

⚠ **WARNING: FUSES/CIRCUIT BREAKERS SHOULD BE INSTALLED TO PROTECT THE CENTRAL DISPLAY MODULE UNDER A FAULT CONDITION, RECOMMENDED SPECIFICATIONS CAN BE FOUND IN THE NEXT SECTION.**

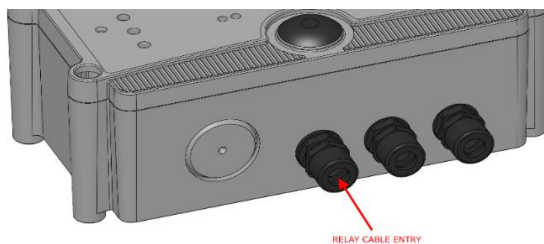

If the built-in relays R1 and R2 are being used, another knockout should be removed from the enclosure and an additional gland should be fitted for the relay cables as show.

Recommended cable:

- Conductor size: 22–14 AWG (solid or stranded)
- Voltage rating: See warnings above
- Flammability: See warnings above

Recommended fusing:

- Voltage/Current rating: 250V/3A
- Time constant: Fast blow or Type B (or faster for MCBs)
- Breaking capacity: High
- Must be UL listed/recognized

9.4.4 Central Display to Sensor

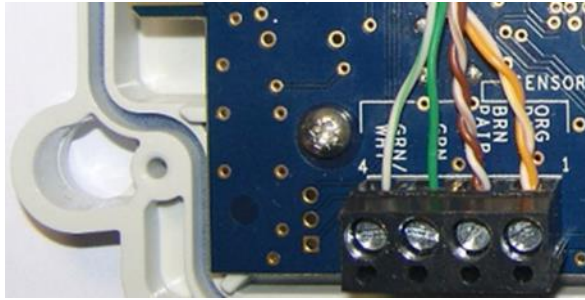

Cable connections from left to right:

GRN/WHT (RS485 A, single cable)

GRN (RS485 B, single cable)

BRN & BRN/WHT (supply negative, two cables twisted together)

ORG & ORG/WHT (supply positive, two cables twisted together)

NOTE: THE BLUE AND BLUE/WHITE CABLES SHOULD BE REMOVED (CUT OFF).

9.4.5 Central Display to Power Supply Unit (PSU)

Two types of PSU are available, to suit different types of installation. One is a plug-in type, the other is a hard-wired type for connection to a fixed power supply (fused spur).

CAUTION: THE HARD-WIRED POWER SUPPLY UNIT SHOULD BE CONNECTED TO A 3A FUSED SPUR, TO ENSURE THAT THE PSU IS PROTECTED FROM POTENTIAL DAMAGE.



PSU, plug-in type (supplied with UK, Eu, US and Aust Plugs)



PSU, hard-wired type (for connection to a fixed power supply)



The plug-in PSU is supplied with a securing strip, wall plugs and screws to reduce risk of accidental disconnection or tampering

WARNING:

THE POSITIVE AND NEGATIVE POWER CABLES ARE IDENTIFIED DIFFERENTLY DEPENDING ON THE TYPE OF PSU SUPPLIED. READ THE INSTRUCTIONS BELOW BEFORE INSTALLING THE PSU CABLE.

Plug-in type PSU cable identification

Black with stripe: Positive (24V)

Black with print: Negative (0V)



Hard wired type PSU cable identification

Black with stripe: Negative (0V)

Black with print: Positive (24V)



9.4.6 Central Display to Optional Beacon (labelled 'STROBE' on the PCB)

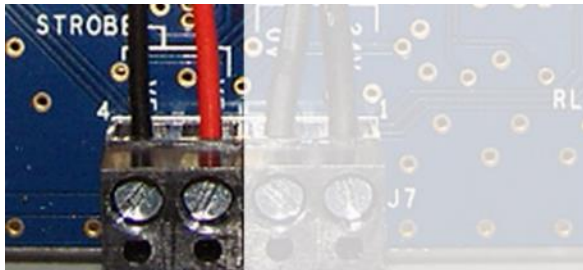

Cable connections from left to right:
 BLK (0V supply to optional beacon)
 RED (24V supply to optional beacon)

CAUTION: CABLE COLOURS BETWEEN THE CENTRAL DISPLAY AND BEACON MAY VARY. THE INSTALLER MAY USE CAT5E CABLE IF PREFERRED, PROVIDING TWISTED PAIRS ARE USED. 15m CABLE IS SUPPLIED AS STANDARD.

9.4.7 Sensor (CO₂ example)

- NOTE: THE FOUR UPPER SCREW TERMINALS ARE FOR CONNECTING THE SENSOR TO THE CENTRAL DISPLAY. ON THE PCB THESE TERMINALS ARE LABELLED 'CENTRAL UNIT'.
- NOTE: THE SIX LOWER SCREW TERMINALS ARE FOR CONNECTING THE SENSOR TO THE ALARM. ON THE PCB THESE TERMINALS ARE LABELLED 'STROBE/SOUNDER'.

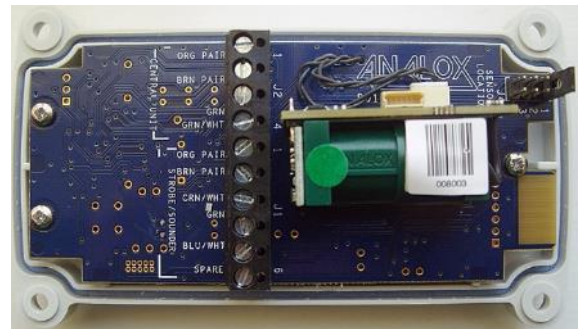

9.4.8 Sensor to Central Display

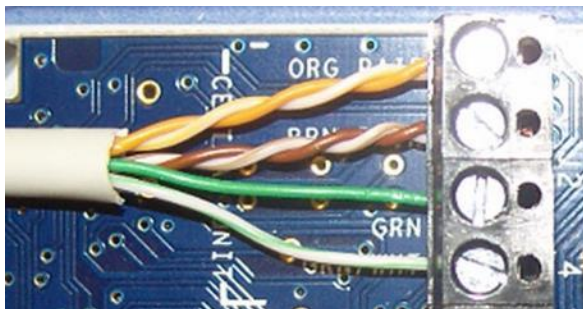

Cable connections from top to bottom:

ORG & ORG/WHT (supply positive, two cables twisted together)

BRN & BRN/WHT (supply negative, two cables twisted together)

GRN (RS485 B, single cable)

GRN/WHT (RS485 A, single cable)

NOTE: THE BLUE AND BLUE/WHITE CABLES SHOULD BE REMOVED (CUT OFF).

- NOTE: SENSOR 2 CABLE SHOULD BE DAISY-CHAINED FROM SENSOR 1 TERMINALS.

9.4.9 Sensor to Alarm

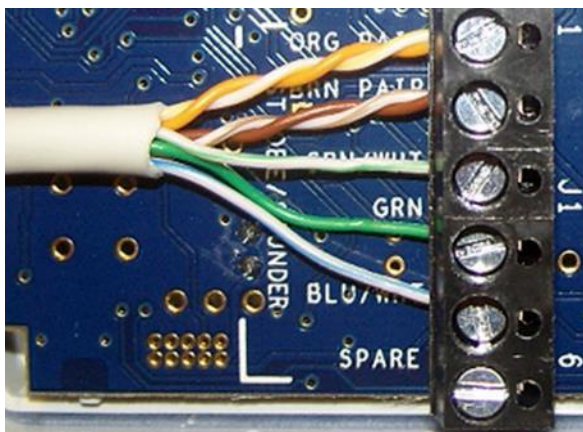

Cable connections from top to bottom:

ORG & ORG/WHT (supply positive, two cables twisted together)

BRN & BRN/WHT (supply negative, two cables twisted together)

GRN/WHT (alarm strobe driver, single cable)

GRN (alarm sounder driver, single cable)

BLU/WHT ('Fault' LED driver, single cable)

NOTE: THE BLUE CABLE SHOULD BE REMOVED (CUT OFF).

9.4.10 Sensor jumper locations



The image to the left shows the jumper link at location 1 (Factory default).

Each Sensor PCB contains a SENSOR LOCATION selector. One jumper link is provided with each sensor—an example is shown here on the right: 

By default this jumper link is fitted in SENSOR LOCATION 1.

Each Sensor must be given a different SENSOR LOCATION by moving its jumper link.

For example, in a two-Sensor system, one Sensor's jumper link must be set to SENSOR LOCATION 1, and the other Sensor's jumper link must be set to SENSOR LOCATION 2.

9.4.11 Alarm



NOTE: ALL ALARMS ASSOCIATED WITH A COMMON SENSOR SHOULD BE CONNECTED VIA A DAISY-CHAIN CABLE ARRANGEMENT. FOR EXAMPLE, IF SENSOR 1 IS REQUIRED TO DRIVE TWO ALARMS, ONE CABLE SHOULD BE CONNECTED BETWEEN SENSOR 1 AND ALARM 1; AND ONE CABLE SHOULD BE CONNECTED BETWEEN ALARM 1 AND ALARM 2 (SEE THE EXAMPLE IN SECTION 0).

9.4.12 Alarm to Sensor

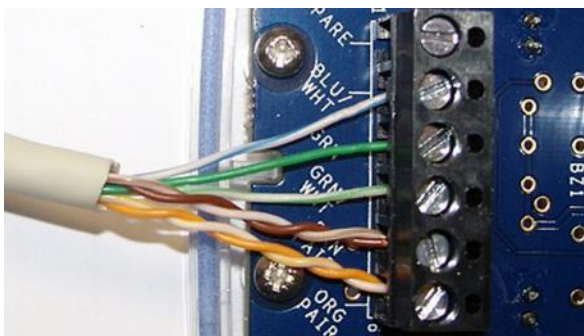

Cable connections from top to bottom:

BLU/WHT (fault LED driver, single cable)

GRN (alarm sounder driver, single cable)

GRN/WHT (alarm strobe driver, single cable)

BRN & BRN/WHT (supply negative, two cables twisted together)

ORG & ORG/WHT (supply positive, two cables twisted together)

NOTE: THE BLUE CABLE SHOULD BE REMOVED (CUT OFF).

9.5 Optional accessories

9.5.1 Beacon

- ⚠ **CAUTION: ENSURE THE TERMINAL BLOCK ON THE UNDERSIDE OF THE BEACON IS FITTED TO THE 0 V AND THE 24 V PINS. THEN ENSURE THAT THE POWER CABLES ARE CONNECTED TO THE 0V AND THE 24 V SCREW TERMINALS.**

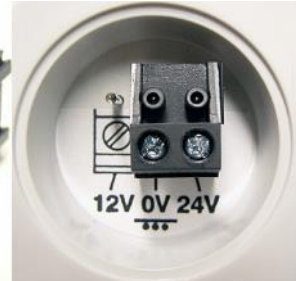

Black cable: 0 V supply to Central Display
Red cable: 24 V supply to Central Display

(left) The beacon terminal block. Ensure this is fitted on the 0 V and 24 V terminals (right)

9.5.1.1 Beacon locking mechanism

The beacon has a locking mechanism to discourage tampering. To lock the beacon onto its base, locate the spigots in position then twist the beacon clockwise. To unlock the beacon, prise open the locking clip as shown below and twist the beacon anti-clockwise.



9.5.2 Data Output Module

9.5.2.1 Data Output Module to Sensor

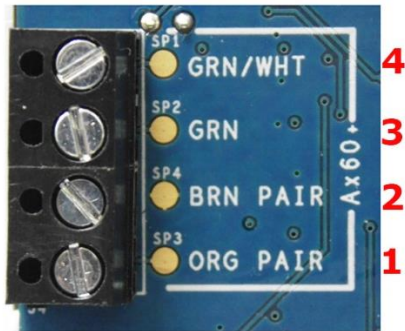

J4 Connections

- J4-4 = Green/White (RS485-B)
- J4-3 = Green (RS485-A)
- J4-2 = Brown Pair (0V)
- J4-1 = Orange Pair (24V)

NOTE: THE BLUE AND BLUE/WHITE CABLES SHOULD BE REMOVED (CUT OFF).

9.5.2.2 Data Output Module Wiring

Each Sensor Unit has a dedicated mA output labelled CH X (where X is 1 to 4) on connector J1 (4-20 mA) as shown in the picture below.

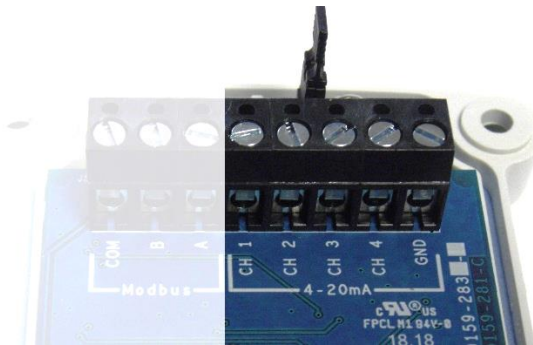

4-20mA SIGNALS (ACTIVE)

- CH 1 = Sensor 1 reading (4-20mA)
- CH 2 = Sensor 2 reading (4-20mA)
- CH 3 = Sensor 3 reading (4-20mA)
- CH 4 = Sensor 4 reading (4-20mA)
- GND = Common ground

NOTE: THE mA ANALOGUE OUTPUTS ARE REFERENCED TO A COMMON GROUND.

Connect suitable wiring between the required output and the measuring device / system. Also ensure the ground connection is made between the GND connector and the measuring device.

Modbus interface connections are on connector J1 (MODBUS) as shown in the picture below. The Modbus interface uses RS485 half-duplex hardware protocol. See Appendix D in the P0159-803 Ax60+ Service Manual for a description of register mappings, contents and communications protocol.

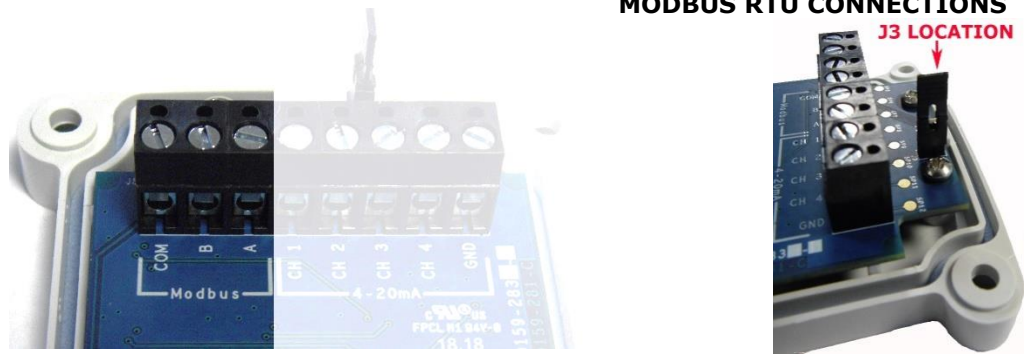

MODBUS connections to a building management system can be made via a RS485 link to the COM, A & B. Refer to the P0159-803 Ax60+ Service Manual.

NOTE: J3 IS USED TO LINK IN THE BUS TERMINATION RESISTOR. THIS LINK IS TO BE FITTED IF THIS MODULE IS THE END NODE ON THE RS485 BUS.

WARNING: TO COMPLY WITH THE SAFETY STANDARDS IN SECTION 18 CIRCUITS CONNECTED TO THE ANALOGUE CURRENT LOOPS OR MODBUS CONNECTIONS MUST BE PROTECTED WITH DOUBLE/REINFORCED INSULATION FROM THE MAINS.

9.5.2.3 Fitting the ferrite cable clamp (US only)

To be compliant with (CFR) part 15 (47CFR15) connect the supplied ferrite clamp as close as possible to the cable gland. The clamp must be only fitted to the BMS communications lead. This applies to both hard wired and quick connect units.



10 Operation (Kiosk)

10.1 Powering on

- [1] **Ensure the components are correctly installed.**
- [2] **Switch on the mains power at the wall socket. The Ax60K powers on and runs a 5-second self-test, during which:**
 - the Alarm indicators illuminate
 - the CO₂ Sensor indicators illuminate
 - the CO₂ Sensor internal buzzer sounds

Following a successful power-on, the CO₂ Sensor begins continuously monitoring the air for CO₂. During normal operation the status of the system is indicated as shown below:

Normal operation with CO₂ at a safe level	CO₂ Sensor indication:	Power indicator flashes once per second. Alarm indicator is off. Buzzer is off.
	Alarm indication:	Power indicator is on. Fault indicator is off. Strobe light is off. Sounder is off.

10.2 Understanding alarms

All alarms on the Ax60+ Kiosk variant are unlatched by default, which means, when an alarm occurs, the unit will go into alarm as normal. When the gas level returns to normal any active alarms will automatically clear without any operator intervention.

The hazard warning/information labels explain what to do in the event of an alarm. The alarms vary depending on the severity of the CO₂ level. Alarms are indicated as follows:

Table 1 Standard Ax60+ Kiosk alarms

TWA alarm (0.5% over previous 8 hours)	CO₂ Sensor indication:	Power indicator flashes once per second. Alarm indicator flashes ¼ second on, 1¾ seconds off. Buzzer sounds in parallel.
	Alarm indication:	Power indicator is on. Fault indicator is off. Strobe light is off. Sounder is off.
High alarm (1.5%)	CO₂ Sensor indication:	Power indicator flashes once per second. Alarm indicator flashes 1 second on, 1 second off. Buzzer sounds in parallel.
	Alarm indication:	Power indicator is on. Fault indicator is off. Strobe light flashes 1 second on, 1 second off. Sounder is off.
High-high alarm (3.0%)	CO₂ Sensor indication:	Power indicator flashes once per second. Alarm indicator flashes ⅓ second on, ⅓ second off. Buzzer sounds in parallel.
	Alarm indication:	Power indicator is on. Fault indicator is off. Strobe light and sounder are ½ second on, ½ second off.

Table 2 US IFC Ax60+ Kiosk alarms

TWA alarm (0.5% over previous 8 hours)	CO₂ Sensor indication:	Power indicator flashes once per second. Alarm indicator flashes 1 second on, 1 second off. Buzzer sounds in parallel.
	Alarm indication:	Power indicator is on. Fault indicator is off. Strobe light is off. Sounder is off.
Low level alarm (AL1) (0.5% pre-alarm)	CO₂ Sensor indication:	Power indicator flashes once per second. Alarm indicator flashes 1 second on, 1 second off. Buzzer sounds 0.5 seconds on, 1.5 seconds off
	Alarm indication:	Power indicator is on. Fault indicator is off. Strobe light flashes every 2 seconds. Sounder sounds 0.5 seconds on every 2 seconds
Low level alarm (AL2) (1.5%)	CO₂ Sensor indication:	Power indicator flashes once per second. Alarm indicator flashes 0.5 seconds on, 0.5 seconds off. Buzzer sounds 1 seconds on, 1 seconds off.
	Alarm indication:	Power indicator is on. Fault indicator is off. Strobe light flashes every 1 second. Sounder sounds 1 second on every 2 seconds.
High level alarm (AL3)(3.0%)	CO₂ Sensor indication:	Power indicator flashes once per second. Alarm indicator flashes 0.5 seconds on, 0.5 seconds off. Buzzer sounds in parallel.
	Alarm indication:	Power indicator is on. Fault indicator is off. Strobe light flashes every 1 second. Sounder sounds 0.5 seconds on every 1 second.

10.2.1 Testing alarms

- [1] **Press and hold down the Accept/Test button for 5–10 seconds. The Ax60K runs a 5-second alarm test, during which:**
- the Alarm indicators illuminate
 - the Alarm strobe light illuminates
 - the Alarm sounder operates
 - the CO₂ Sensor indicators illuminate
 - the CO₂ Sensor internal buzzer operates
- [2] **Either press and hold down Accept/Test to stop the alarm test or wait 5 seconds for the alarm test to stop automatically.**

10.2.2 Acknowledging/clearing alarms

The operator can either press and hold Accept/Test until the buzzer sounds once; the alarm is now acknowledged. The buzzer and sounder are muted and the strobe stays on until the alarm is cleared or can wait until the gas level returns to normal (it clears automatically as soon as the CO₂ level reduces to below the alarm threshold).

 **NOTE: BY DEFAULT, AX60K SYSTEM ALARMS ARE SELF-CANCELLING WHEN THE CARBON DIOXIDE LEVEL FALLS BELOW THE ALARM LIMITS. ALTERNATIVELY ALARMS CAN BE SET AS LATCHED (USING THE KIOSK CONFIG TOOL), IN WHICH CASE THE AX60K WILL REMAIN IN ALARM UNTIL MUTED AND ACKNOWLEDGED.**

10.3 Controls and indicators



1 Power indicator (green LED)

If the Power indicator flashes once per second:

- Sensor is receiving power and operating correctly

If the Power indicator is off:

- Sensor is not receiving power, **or** the Sensor has a fault

If the Power indicator is continuously on:

- Sensor has a fault

2 Alarm indicator (red LED)

The Alarm indicator has three flash patterns, one for each type of alarm:

- ¼ second on, 1¾ seconds off = time-weighted average (TWA) alarm (0.5% CO₂ average over 8 hours).
- 1 second on, 1 second off = 1.5% CO₂.
- ⅛ second on, ⅛ second off = 3% CO₂.

If the Alarm indicator is continuously on:

- the alarm is acknowledged; the alarm will clear when the air returns to normal

3 Accept/Test button

To use the Accept/Test button, press it firmly and hold it down for a couple of seconds. When you release the button, the buzzer will sound once.

4 Internal buzzer

The buzzer sounds briefly when you press Accept/Test, continuously for 5 seconds when the Ax60K powers up, once per second to show a fault, and also in parallel with the alarms.

5 Sensor opening

The sensor opening allows air to flow across the carbon dioxide detector. The sensor opening must be kept clean and free from obstructions.



1 Power indicator (green LED)

If the Power indicator is on (not flashing):

- Alarm is receiving power
NOTE: The Alarm receives its power from the Sensor.

If the Power indicator is off:

- Alarm is not receiving power, **or**
- Alarm has a fault
NOTE: If the Sensor has a fault, the Alarm's Fault indicator LED will flash.

2 Fault indicator (yellow LED)

If the Fault indicator is off:

- Sensor is functioning correctly

If the Fault indicator flashes once per second:

- Sensor has a fault
NOTE: The Fault indicator LED does not mean there is a fault on the Alarm, it means there is a fault on the Sensor.

3 Strobe light

The strobe light is a very bright, visible alarm.

NOTE: The strobe window can be supplied in White, blue, red or amber.

The strobe light has two flash patterns:

- 1 second on, 1 second off = 1.5% CO₂.
- ½ second on, ½ second off = 3% CO₂.

4 Sounder

The sounder is a high-volume audible alarm.

If sounder is ½ second on, ½ second off, the CO₂ Sensor has triggered a high alarm (3%).

11 Operation (HW & QC)

11.1 Central Display

The Central Display is used to configure and operate the system. The three buttons on the front panel allow access to the software functions. The three indicator lamps and the internal buzzer provide information about the system status, as described below.



11.1.1 Indicators and buzzer

Power	Green indicator lamp. Flashes once per second to indicate that the power is on and the unit is operating.
Fault	Yellow indicator lamp. Flashes once per second if there is a fault, accompanied by a fault message (FLT or COMMS FAULT) and buzzer once per second.
Alarm	Red indicator lamp. Flash rate will vary depending on alarm level and will be accompanied by an alarm message (TWA, AL1, CO2 etc.) The buzzer will follow the lamp indicator flash rate.
Buzzer (the small circular aperture on the left of the indicators)	Buzzer sounds briefly each time a button is pressed. Sounds continuously for five seconds during an alarm test. It sounds rapidly on and off when an alarm is triggered, or once per second for a fault.

11.1.2 Control buttons

Cancel	To use the Cancel button, press it firmly then release it quickly. The buzzer will sound briefly. Press this button to cancel a menu option or to return to the previous screen.
Cycle	To use the Cycle button, press it firmly then release it quickly. The buzzer will sound briefly. Press this button to go to the next option on the screen.
Accept/Test	To use the Accept/Test button, press it firmly then release it quickly; the buzzer will sound. A short press is used to select an option or mute an alarm or fault. A longer press is used to acknowledge the alarm—hold the button until the buzzer sounds. The alarm clears when the alarm condition clears. To test the alarms, press and hold down Accept/Test until the buzzer sounds. Alarms, indicators and sounders operate for five seconds. Relays are not tested. During this time the screen will display 'TESTING ALARMS'.

11.2 Sensor

Each Ax60+ Sensor has a green Power indicator on the bottom left-hand part of the fascia. This is used to indicate the following conditions:

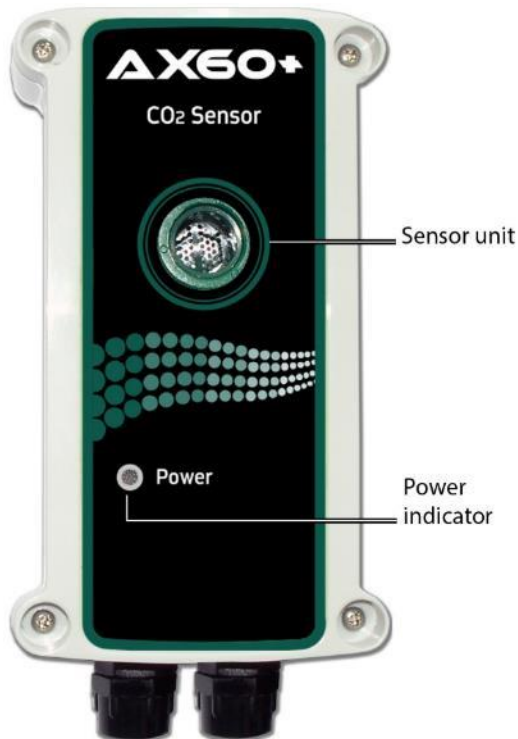

Power indicator

Under normal conditions the Power indicator flashes once per second to indicate that the power is on and the unit is operating.

📌 **NOTE: THE SENSOR RECEIVES ITS POWER FROM THE CENTRAL DISPLAY, VIA THE CONNECTING CAT5E CABLE.**

If the Power indicator is off, this means that the Sensor is either not receiving power from the Central Display, or the Sensor has a fault.

📌 **NOTE: CHECK THE CENTRAL DISPLAY; IT MAY BE SHOWING A FAULT CODE.**

If the Power indicator lamp is on continuously, this means that there is potentially a more serious Sensor fault.

📌 **NOTE: CHECK THE CENTRAL DISPLAY; IT MAY BE SHOWING A FAULT CODE.**

If a Sensor is in fault, any Alarms connected to it will also display a fault status (their yellow Fault indicator LEDs will flash).

📌 **NOTE: FAULT CODES ARE DESCRIBED IN DETAIL IN THE SERVICE MANUAL.**

11.2.1 Sensor hardware settings

In a standard Ax60+ system (not including the Kiosk option) each sensor must have its jumper link set to a different location e.g. Sensor 1=location 1; Sensor 2=location 2.

The Sensor has a hardware setting that is factory configured for a system with only one Sensor. If a system includes two, three, or four Sensors then the hardware must be reconfigured by moving a jumper link () in each Sensor installed in the system.

⚠️ **WARNING: DISCONNECT AND ISOLATE THE AX60+ SYSTEM FROM THE MAINS POWER SUPPLY BEFORE OPENING THE CO₂ SENSOR ENCLOSURES.**

To access the jumper link, open the Sensor enclosure. The printed circuit board (PCB) has a SENSOR LOCATION selector with one link, factory installed in LOCATION 1.

The image to the right shows the jumper link in position 1 (Factory default).

For a system with only **one Sensor**, the jumper link should be retained in LOCATION 1.

For a system with **two Sensors**, the first Sensor's jumper link should be in LOCATION 1 and the second Sensor's link in LOCATION 2.

For a system with **three Sensors**, the first Sensor's link should be in LOCATION 1, the second Sensor's link in LOCATION 2 and the third Sensor's link should be in LOCATION 3.

For a system with **four Sensors**, the first Sensor's jumper link should be in LOCATION 1, the second Sensor's link in LOCATION 2, the third Sensor's link in LOCATION 3 and the fourth Sensor's link should be in LOCATION 4.

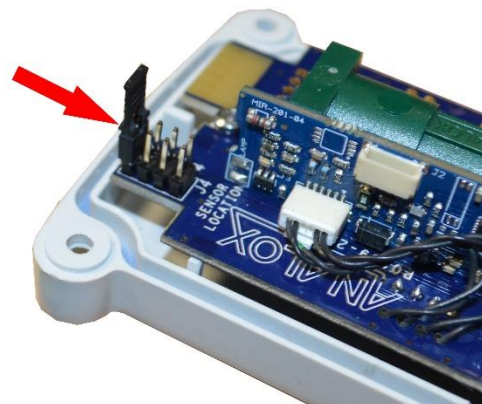

11.3 Alarm

The Ax60+ Alarm has both a green Power indicator and a yellow Fault indicator on the bottom part of the fascia. These are used to indicate the following conditions:

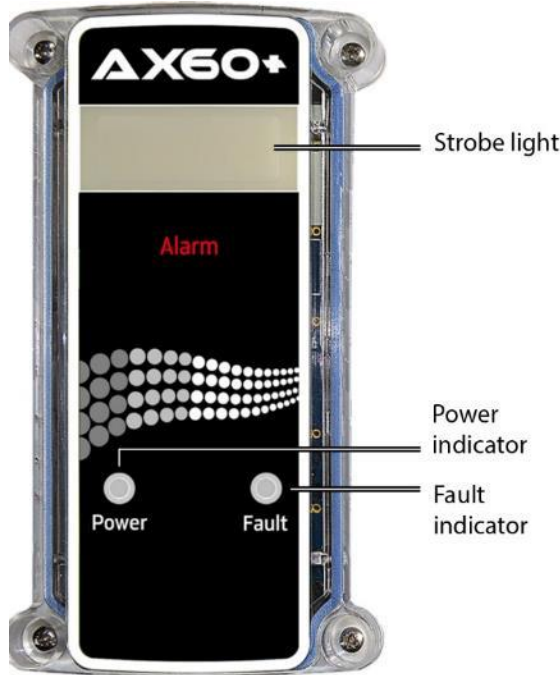

NOTE: The sounder is on the rear of the enclosure

Power indicator

Under normal conditions the Power indicator is continuously on (not flashing) to indicate that the power is on and the unit is operating.

📌 **NOTE: THE ALARM RECEIVES ITS POWER FROM THE SENSOR VIA THE CONNECTING CAT5E CABLE.**

If the Power indicator is off this means that the Alarm is not receiving power.

Fault indicator

Under normal conditions the yellow Fault indicator is off.

📌 **NOTE: THE FAULT INDICATOR IS NOT USED TO SHOW FAULTS ON THE ALARM, IT IS USED TO SHOW FAULTS ON THE SENSOR CONNECTED TO IT.**

If the Fault indicator is flashing it means the Sensor connected to the Alarm is in fault.

📌 **NOTE: FAULT CODES ARE SHOWN ON THE CENTRAL DISPLAY. FOR FURTHER DETAILS SEE THE SERVICE MANUAL.**

11.4 Data Output Module (optional)

The Ax60+ Data Output Module has both a green Power indicator and a yellow Fault indicator on the bottom part of the fascia. These are used to indicate the following conditions:



Power indicator

Under normal conditions the Power indicator flashes once per second to indicate that the power is on and the module is operating.

📌 **NOTE: THE DATA OUTPUT MODULE RECEIVES ITS POWER FROM THE CENTRAL DISPLAY, VIA THE CONNECTING CAT5E CABLE.**

If the Power indicator is off, this means that the module is either not receiving power from the Central Display, or the module has a fault.

If the Power indicator lamp is on continuously, this means that there is potentially a more serious Sensor fault.

Fault indicator

Under normal conditions the yellow Fault indicator is off.

📌 **NOTE: THE FAULT INDICATOR IS NOT USED TO SHOW FAULTS OF THE SENSORS, IT IS USED TO SHOW INTERNAL FAULTS ON THE DATA OUTPUT MODULE ONLY.**

If the Fault indicator is flashing it means the module has an internal fault.

📌 **NOTE: THE REST OF THE AX60+ MAY NOT BE SHOWING A FAULT.**









12 Software



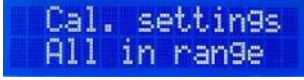

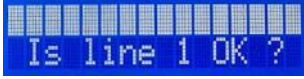

This section gives a brief overview of the software. For full details of the menu options relevant to calibration and configuration, refer to the *Ax60+ Service Manual P0159-803*.

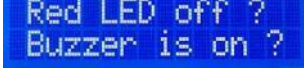
NOTE: THIS SECTION SPECIFICALLY RELATES TO THE AX60+ STANDARD OPTIONS HW AND QC. HOWEVER, A CENTRAL DISPLAY CAN BE TEMPORARILY CONNECTED TO THE AX60K KIOSK TO ENABLE A SERVICE ENGINEER TO RECONFIGURE THE SYSTEM.

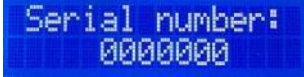
12.1 Powering up

When you power up the Ax60+, the software performs an automatic power-on-self-test (POST) which takes about 30 seconds. The results are shown on the Central Display.

Operator input	Software response	Central Display text	Optional text / notes
Switch on power supply to Ax60+	Displays vendor name and website (default is Analox Ltd)		Vendor name may vary
No further operator input is required. The POST is an automatic process	Performs a checksum configuration check		
	Performs a software validation check		
	Checks the Sensor(s) have been calibrated		
	Confirms top line of LCD OK, no pixels are missing		No sensors are configured
	Confirms bottom line of LCD OK, no pixels missing		
	Confirms buzzer is off and green LED switches on		
	Confirms green LED is off and yellow switches on		
	Confirms yellow LED is off and red switches on		
	Confirms red LED is off and buzzer switches on		

Operator input	Software response	Central Display text	Optional text / notes
	Displays current software. Buzzer switches off		
	Displays unique serial number of the unit		
Wait for Sensors to warm up...			This screen may display for a few seconds to show warm-up status. It requires no operator input
			For 1 sensor it will take approximately 30 seconds for warmup, for a 4 sensor system it can take up to 2 minutes for all sensors to complete warmup
	CAUTION: EACH SENSOR MUST HAVE ITS JUMPER SET TO A DIFFERENT LOCATION (E.G. SENSOR 1 = LOCATION 1; SENSOR 2 = LOCATION 2), OTHERWISE THE CENTRAL DISPLAY WILL ANNOUNCE A FAULT.REFER TO SECTION 9.4.10 FOR JUMPER SETTINGS INFORMATION.		
Wait for system status screen...	Displays system status screen. Each Sensor is represented by 'OK' in the top line. For example, a system with two Sensors displays >OK OK. The '>' character identifies which Sensor is highlighted (Sensor 1 is highlighted by default)		The example here shows that Sensor 1, a CO ₂ Sensor, is reading 450 PPM, which is equal to 0.045%. The concentration is displayed in ppm (parts per million) by default
	NOTE: THE SYSTEM STATUS SCREEN DISPLAYS UP TO 4 SENSORS. A SPARE SENSOR LOCATION DISPLAYS AS: '---'		
	The bottom line displays the concentration of gas measured at the Sensor		
Press Cycle	Displays Sensor 2 details (if installed) and the current level of gas		In this example, Sensor 2 is a carbon dioxide (CO ₂) Sensor
Press Cycle	Displays Sensor 3 details (if installed) and the current level of gas		In this example, Sensor 3 is not installed
Press Cycle	Displays Sensor 4 details (if installed) and the current level of gas		In this example, Sensor 4 is not installed
Press Cycle	Redisplays the system status screen		

12.2 Central Display screen

The Central Display has a two-line screen that provides real-time gas readings from up to four Sensors. The top line of the screen shows the status of Sensors 1, 2, 3 and 4, from left to right. The chevron/asterisk shows the number of the highlighted Sensor, its gas type, current reading and unit of measurement. If a system fault or a communications fault occurs, this displays on the bottom line in place of the current reading and unit of measurement. Under normal conditions the currently highlighted Sensor is identified by a chevron ('>') to its left. This changes to an asterisk ('*') if the Sensor goes into alarm or fault. When the alarm or fault is acknowledged and the alarm condition clears the symbol reverts to a chevron.

Sensor 1 status is currently 'OK'.
Sensor 2 status is currently 'OK'.

Sensor 3 status is currently '----' (this means that Sensor 3 is NOT installed).
Sensor 4 status is currently '----' (this means that Sensor 4 is NOT installed).



The screenshot shows a two-line display. The top line has four indicators: '>OK', 'OK', '----', and '----'. The bottom line shows 'CO2', '450', and 'PPM'. Red arrows point from the text to these elements: the chevron, the 'OK' status, the 'CO2' gas type, the '450' reading, and the 'PPM' unit.

A chevron symbol ('>') is used to identify the currently selected Sensor, in this example Sensor 1. If a Sensor is in 'Alarm' or 'Fault', then an asterisk ('*') is used to identify the Sensor instead of the chevron symbol.

The gas type of the selected Sensor (In this case CO₂). If any of the Sensors triggers an alarm, it then becomes the selected Sensor. The screen automatically jumps to the Sensor currently in alarm.

Unit of measurement; ppm (an abbreviation of 'parts per million') denotes the gas level. Converting to percent is straightforward, e.g. 450 ppm = 0.045%; 15,000 ppm = 1.5%; 30,000 ppm = 3%.

Live gas measurement at the selected Sensor. Alternatively this could display 'COMMS FAULT' or 'FLT ##' if there is a system or Sensor fault.

There are seven possible statuses for each Sensor. These are described in the example below:

Status	Meaning	Example
OK	Sensor 1 & sensor 2 are functioning correctly	>OK OK --- --- CO2 450 PPM
---	Sensor 3 & sensor 4 shown as not installed	OK OK >--- --- Not installed
TWA	Alarm 1 on sensor 1 (Carbon Dioxide) has been triggered. <i>Example shown - Default set point is 5000ppm over the previous 8 hours.</i>	*TWA OK --- --- CO2 5050 PPM
AL1	Alarm 2 on sensor 1 (Carbon Dioxide) has been triggered. <i>Example shown - Default set point is 15000ppm (1.5% CO₂)</i>	*AL1 OK --- --- CO2 15050 PPM
CO2	Alarm 3 on sensor 1 (Carbon Dioxide) has been triggered. <i>Example shown - Default set point is 30000ppm (3.0% CO₂)</i>	*CO2 OK --- --- CO2 35050 PPM
AL3	Alarm 3 on sensor 2 (Oxygen) has been triggered. <i>Example shown - Default set point is 23.0% O₂</i>	OK *AL3 --- --- O2 23.0 %
FLT ##	Sensor 1 (and sensor 2) has developed a system fault (refer to the Service Manual for fault codes)	*FLT FLT --- --- SNR 1 FLT05
FLT COMMS	Sensor has developed a communications fault (refer to the Service Manual for fault codes) – Check system wiring.	*FLT FLT --- --- SNR 1 COMMS FLT

NOTE: UNACKNOWLEDGED ALARMS AND FAULTS ARE INDICATED BY AN ASTERISK.

12.3 Alarms

The Ax60+ has four user selectable alarm levels. These are pre-set by Analox and may only be changed by an authorised installer or service engineer. The default alarm levels for carbon dioxide and oxygen are described below.

12.3.1 Standard carbon dioxide sensors

Alarm	CO ₂ threshold	Annunciation (text, buzzer, indicators, strobe, sounder, optional beacon)		
		Central Display	Alarm units	Beacon
TWA <i>time weighted average</i>	0.5% (5000ppm) average, over the previous 8 hours	Display text: *TWA; buzzer & red LED on	All Alarms off; annunciation by Central Display only	Flashing
AL1 <i>High alarm</i>	At or above 1.5% (15,000ppm)	Display text: *AL1; buzzer on; flashing red LED on	Alarm(s) connected to the affected Sensor only: slowly flashing strobe (1 second on 1 second off), no sounder	Flashing
CO2 <i>High-High alarm & evacuation mode</i>	At or above 3% (30,000ppm)	Display text: *CO2; buzzer on; flashing red LED and relays on	All Alarms: rapidly flashing strobe lights (½ second on ½ second off); sounders on (½ second on ½ second off)	Flashing
AL4 <i>(Disabled by default, see service manual on how to enable)</i>	At or above 3.5% (35,000ppm)	Display text: *AL4; buzzer on; flashing red LED and relays on	All Alarms: rapidly flashing strobe lights (½ second on ½ second off); sounders on (½ second on ½ second off)	Flashing

To clear alarms, they must first be muted and acknowledged in the following sequence:

1) Mute: To mute (silence) an alarm, briefly press the Accept/Test button. The buzzer will sound once and the Alarm sounders will be silenced. However, the strobe lights on the Alarm and the optional beacon (if installed) will continue to flash.

2) Acknowledge: To acknowledge an alarm, press Cycle until the asterisk is located next to the sensor you wish to acknowledge, then press and hold the Accept/Test button for approximately two seconds. The buzzer on the Central Display will sound briefly and the text changes: the asterisk is replaced with a chevron, for example '*AL1' becomes '>AL1'.

3) Clear: An alarm that has been muted and acknowledged will automatically clear as soon as the monitored gas returns to a safe level (there may be a delay before the alarm clears). When the alarm clears, the screen text changes to '>OK'.

12.3.2 US IFC carbon dioxide sensors

Alarm	CO ₂ threshold	Annunciation (text, buzzer, indicators, strobe, sounder, optional beacon)		
		Central Display	Alarm units	Beacon
TWA <i>time weighted average</i>	0.5% (5000ppm) average, over the previous 8 hours	Display text: *TWA; buzzer & red LED on	All Alarms off; annunciation by Central Display only	Flashing
AL1 <i>Low level Pre alarm</i>	At or above 0.5% (5,000ppm)	Display text: *AL1; buzzer on; flashing red LED and relay 1 on	Alarm(s) connected to the affected Sensor only: Strobe light flashes every 2 seconds. Sounder sounds 0.5 seconds on every 2 seconds	Flashing
AL2 <i>Low level alarm</i>	At or above 1.5% (15,000ppm)	Display text: *AL2; buzzer on; flashing red LED and relay 1 on	Alarm(s) connected to the affected Sensor only: Strobe light flashes every 1 second. Sounder sounds 1 second on every 2 seconds.	Flashing
AL3 <i>High level alarm & evacuation mode</i>	At or above 3.0% (30,000ppm)	Display text: *AL3; buzzer on; flashing red LED and both relays on	All Alarms: Strobe light flashes every 1 second. Sounder sounds 0.5 seconds on every 1 second.	Flashing

By default, IFC system alarms are self-cancelling when the Carbon Dioxide level falls below the alarm limits. Alternatively alarms can be set as latched, in which case the Ax60+ will remain in alarm until muted and acknowledged in the following sequence:

- 1) Mute:** To mute (silence) an alarm, briefly press the Accept/Test button. The buzzer will sound once and the Alarm sounders will be silenced. However, the strobe lights on the Alarm and the optional beacon (if installed) will continue to flash.
- 2) Acknowledge:** To acknowledge an alarm, press Cycle until the asterisk is located next to the sensor you wish to acknowledge, then press and hold the Accept/Test button for approximately two seconds. The buzzer on the Central Display will sound briefly and the text changes: the asterisk is replaced with a chevron, for example '*AL1' becomes '>AL1'.
- 3) Clear:** An alarm that has been muted and acknowledged will automatically clear as soon as the monitored gas returns to a safe level (there may be a delay before the alarm clears). When the alarm clears, the screen text changes to '>OK'.

12.3.3 Oxygen

Alarm	O ₂ threshold	Annunciation (text, buzzer, indicators, strobe, sounder, optional beacon)		
		Central Display	Alarm units	Beacon
AL1 <i>low alarm</i>	19.5% or below	Alarm is disabled by default.	Alarm is disabled therefore the strobe will not flash and the sounder will not sound	Disabled
AL2 <i>low alarm</i>	19.5% or below	Display text: AL2; buzzer on; flashing red LED and relays on	Alarm(s) connected to the affected Sensor only: slowly flashing strobe (1 second on 1 second off), no sounder	Flashing
AL3 <i>high-high alarm</i>	23% or above	Display text: AL3; buzzer on; flashing red LED and relays on	Alarm(s) connected to the affected Sensor only: rapidly flashing strobe lights (½ second on ½ second off); sounders on (½ second on ½ second off)	Flashing
AL4 <i>low-low alarm</i>	18% or below	Display text: AL4; buzzer on; flashing red LED and relays on	Alarm(s) connected to the affected Sensor only: rapidly flashing strobe lights (½ second on ½ second off); sounders on (½ second on ½ second off)	Flashing

NOTE: EVACUATION MODE IS NOT SET BY DEFAULT ON THE O₂ SENSOR, IF REQUIRED FOR THE O₂ SENSOR PLEASE CONFIGURE AS PER THE SERVICE MANUAL.

NOTE: BY DEFAULT, IFC AX60+ OXYGEN ALARMS ARE SELF-CANCELLING WHEN THE OXYGEN LEVEL RETURNS TO WITHIN NORMAL LIMITS. ALTERNATIVELY ALARMS CAN BE SET AS LATCHED IN WHICH CASE THE AX60+ OXYGEN ALARM WILL REMAIN IN ALARM UNTIL MUTED AND ACKNOWLEDGED.

To clear alarms, they must first be muted and acknowledged in the following sequence:

1) Mute: To mute (silence) an alarm, briefly press the Accept/Test button. The buzzer will sound once and the Alarm sounders will be silenced. However, the strobe lights on the Alarm and the optional beacon (if installed) will continue to flash.

2) Acknowledge: To acknowledge an alarm, press Cycle until the asterisk is located next to the sensor you wish to acknowledge, then press and hold the Accept/Test button for approximately two seconds. The buzzer on the Central Display will sound briefly and the text changes: the asterisk is replaced with a chevron, for example `*AL2` becomes `>AL2`.

3) Clear: An alarm that has been muted and acknowledged will automatically clear as soon as the monitored gas returns to a safe level (there may be a delay before the alarm clears). When the alarm clears, the screen text changes to `>OK`.

12.3.4 Testing alarms

To test the alarms, press and hold down the Accept/Test button for two seconds. The indicator LEDs illuminate, the screen displays `TESTING ALARMS` and the buzzer sounds. Strobes and sounders on the Alarm(s) switch on. The optional beacon flashes (if installed). Relays are not tested. The alarm test is automatically cancelled (switched off) after five seconds.

12.4 Faults

Faults are reported by the Ax60+ if there is a problem with cable connections, power supplies or system components. A basic understanding of how fault types are displayed may be useful when describing them to an authorised technician or a service engineer.

NOTE: THE AX60+ IS DESIGNED TO PRIORITISE ALARMS OVER FAULTS. FOR EXAMPLE, IN A SYSTEM WITH TWO SENSORS, IF SENSOR 1 IS IN FAULT AND SENSOR 2 GOES INTO ALARM, THE ALARM TAKES PRIORITY.

12.4.1 Fault types

A fault may be categorised as either a system fault, a communications fault or a Central Display fault. All three types display the text 'FLT' but in different parts of the screen. A Central Display fault is not announced by the Sensors or Alarms, but by the Central Display only. The table below shows examples of the three different fault types.

Status	Meaning	Example
FLT (system)	This indicates that a Sensor has developed a system fault. In the example on the right, Sensor 1 is in fault state FLT05 (see the Service Manual for fault codes)	
FLT (comms)	This indicates that a Sensor has developed a communications fault. In the example on the right, Sensor 1 has a COMMS FAULT (see the Service Manual for fault codes)	
FLT (Central Display)	This indicates that the Central Display has developed a fault. In the example on the right, the Central Display is in fault FLT51 (see the Service Manual for fault codes)	

12.4.2 Muting, acknowledging and clearing faults

Faults are announced by the Central Display buzzer which sounds once per second. Alarms do not operate. To clear a fault, it must be muted and acknowledged as below:

1) Mute: To mute (silence) a fault, briefly press the Accept/Test button. The internal buzzer will sound once and then be silenced.

2) Acknowledge: To acknowledge a fault, press and hold the Accept/Test button for approximately two seconds. The buzzer on the Central Display will sound briefly and the text changes: the asterisk is replaced with a chevron, for example '*FLT' becomes '>FLT'.

3) Clear: A fault that has been muted and acknowledged will automatically clear as soon as the fault is rectified.

NOTE: IF A FAULT IS REPORTED BY MORE THAN ONE SENSOR, YOU MUST MUTE, ACKNOWLEDGE AND CLEAR THE FAULT ON THE FIRST SENSOR. THEN PRESS CYCLE TO HIGHLIGHT THE NEXT SENSOR AND REPEAT THE MUTE/ACKNOWLEDGE/CLEAR.

12.4.3 Simultaneous alarms and faults

In a multi-sensor system it is possible for Sensors to be in different states, e.g. Sensor 1 OK; Sensor 2 in alarm level 2; Sensor 3 in fault; Sensor 4 not installed. For example:





Sensor	Status	Meaning	Example
1	OK	Sensor 1 is operating normally (OK)	
2	*AL1	Sensor 2 is in level 1 alarm, it is unacknowledged (*) and has been highlighted	
3	FLT	Sensor 3 is in fault (FLT) and is unacknowledged	
4	---	Sensor 4 is not installed	

13 Configuration

13.1 Sensor software settings

The Central Display software is factory configured for a system that has one sensor. If instead the system has two, three, or four sensors, the software must be reconfigured. This is done by using the Top-level Menu, Central Config, Attached snrs option. To enter the Top-level menu, press and hold down Cancel + Cycle for at least six seconds. Then press the Cycle button five times to display the Top-level menu, Central Config option.

NOTE: THE DEFAULT SETTING IS FOR 1 SENSOR. THIS NUMBER CAN BE CHANGED.

Menu option	Operator input	Menu sub-option	Functional description
	▼ Press Accept/Test to go to Central Menu Attached snrs ►		
	▼ Press Accept/Test to go to Num of sensors? ►		The screen displays the number of Sensors (default number is '>1')
	▼ Press Cycle to choose another number. Or press Accept/Test ►		The screen displays a tick to confirm the number of sensors that are currently configured

Press Cancel to return to Config. Menu, Attached snrs

14 Maintenance

This section describes routine preventive maintenance for the Ax60+. For more detailed information on servicing, refer to the *Ax60+ Service Manual P0159-803*.

14.1 Faults

Faults are announced by the Fault indicator on either the Central Display or the Alarm. This indicator is off during normal operation. If it flashes once per second, the system has a fault. Power off the system and call a service engineer.

14.2 Calibration

The Ax60+ CO₂ Sensors are factory calibrated and do not require periodic calibration adjustment. However, a software option enables an authorised service engineer to adjust the sensor calibration, should this be required by local Health & Safety regulations.

Analox recommend a minimum of an annual calibration is performed on the Ax60+ O₂ Sensors.

14.3 Cleaning

Analox recommends periodic cleaning of Ax60+ enclosures with a slightly damp cloth.

◆ **CAUTION: THE SENSOR UNIT(S) MUST BE PROTECTED FROM INGRESS OF WATER.**

14.4 Protection

Sensors mounted at low level are vulnerable to accidental damage. To protect the Sensors, Analox recommends fitting a Sensor Protection Kit, part number P0159-4305K, shown below (not to scale). The splashguard is fitted on the outside of the sensor opening. The sensor protector is wall mounted using the fixing kit.



Optional Ax60+ Sensor Protection Kit. Available from Analox: part number P0159-4305K (See section 14.4.1 for mechanical details of the sensor protector).

14.4.1 Sensor protector mechanical detail

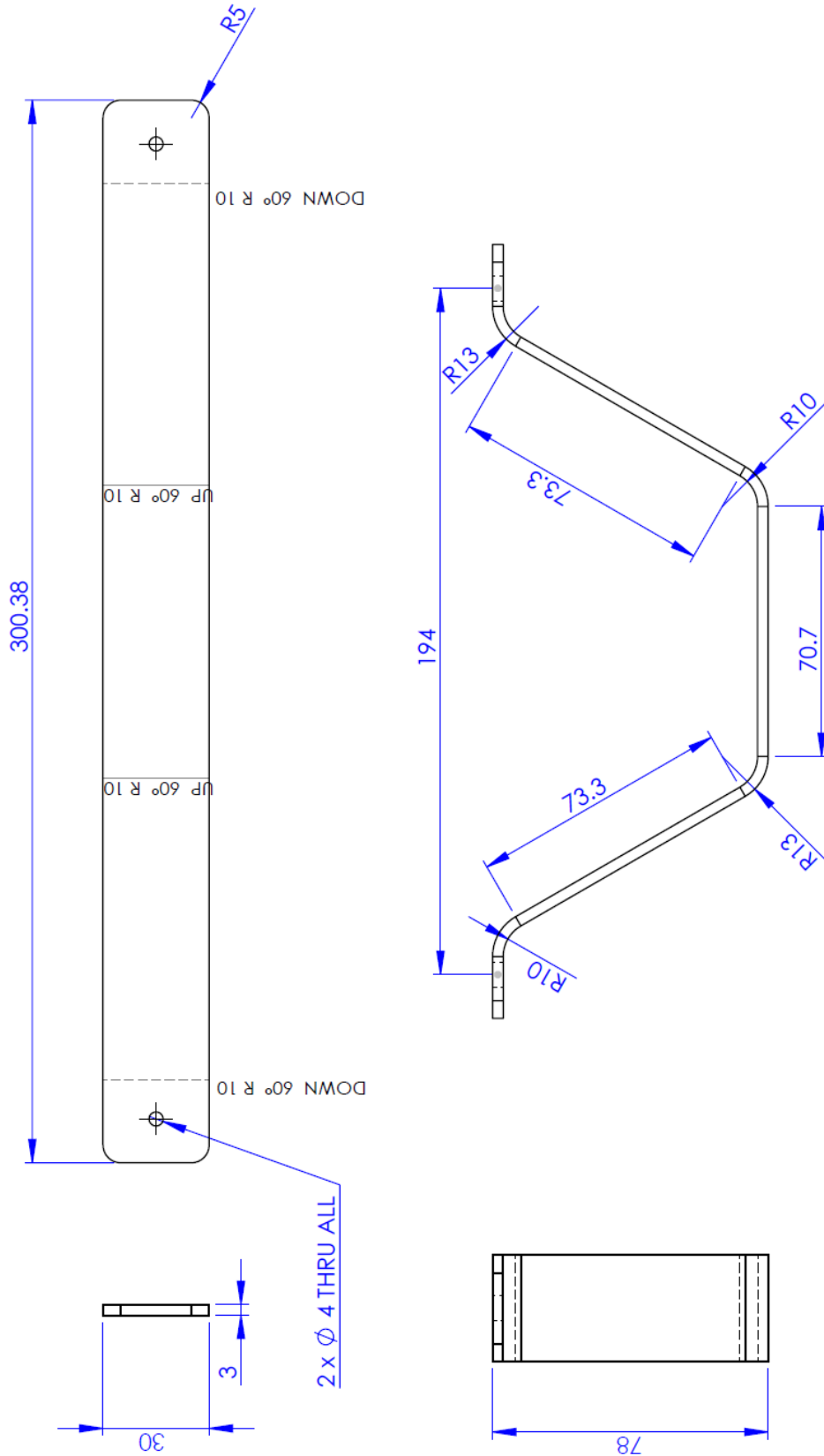

15 Specification

The Ax60+ is designed to be compliant with the following standard: IEC 61010-1:2010. It is designed to be safe at least under the conditions listed below.

⚠ WARNING: IF THE EQUIPMENT IS USED IN A MANNER NOT SPECIFIED BY ANALOX, THE PROTECTION PROVIDED BY THE EQUIPMENT MAY BE IMPAIRED.

Notes accompanying the specification text:

- (*) Limited energy circuits according to IEC 61010-1:2010 clause 9.
- (*) Double insulation and reinforced insulation according to IEC 61010-1:2010.
- (**) Please contact Analex for use in condensing environments.
- (***) IP protection was not evaluated by UL.

15.1 Central Display

- When supplied by a limited energy double/reinforced insulation power supply (*)
- Indoor use
- Altitude up to 2000 m (or 6050ft)
- Operating temperature range: -5 °C to +50 °C
- Maximum relative humidity: 95 %rh (non-condensing)
- Pollution degree 2
- Operating voltage: 24 V DC
- Unit power: <36 W
- Ingress Protection: IP54 (***)
- Not for use in corrosive or explosive atmospheres

Features:

- 2 internal SPDT relays, rated for 250V AC/30V DC, 3A max
- Digital communications
- Internal buzzer
- Power/fault/alarm indications
- 16-character x 2-line LCD display
- External beacon drive channel

15.2 CO₂ Sensor

- When supplied by a limited energy double/reinforced insulation power supply (*)
- Indoor/outdoor use
- Range 0 to 5% CO₂
- Warmup time 40 seconds
- Altitude up to 3050m (Or 10000ft)
- Operating temperature range: -5 °C to +50 °C
- Maximum relative humidity: 98 %rh (non-condensing) (**)
- Pollution degree 2
- Operating Voltage: 24 V DC
- Unit power: <25 W
- Ingress Protection: IP55 (***)
- Not for use in corrosive or explosive atmospheres

Features:

- Green power LED
- Digital Communications

15.3 O₂ Sensor

- When supplied by a limited energy double/reinforced insulation power supply (*)
- Indoor/outdoor use
- Range 0 to 25% O₂
- Warmup time 60 minutes
- Altitude up to 3050m (Or 10000ft)
- Operating temperature range: -5 °C to +50 °C
- Maximum relative humidity: 98 %rh (non-condensing) (**)
- Pollution degree 2
- Operating Voltage: 24 V DC
- Unit power: <25 W
- Ingress Protection: IP55 (***)
- Not for use in corrosive or explosive atmospheres

Features:

- Green power LED
- Digital Communications

15.4 Alarm

- When supplied by a limited energy double/reinforced insulation power supply (*)
- Indoor/outdoor use
- Altitude up to 3050m (Or 10000ft)
- Operating temperature range: -5 °C to +50 °C
- Maximum relative humidity: 98%RH (non-condensing) (**)
- Pollution degree 2
- Operating Voltage: 24 V DC
- Unit power: <5 W
- Ingress Protection: IP55 (***)
- Not for use in corrosive or explosive atmospheres

Features:

- Sounder: 88 dBA @ 3 m
- LED Strobe: 100 cd
- Green power LED
- Yellow fault LED

15.5 Data Output Module (optional)

- When supplied by a limited energy double/reinforced insulation power supply (*)
- Indoor use
- Altitude up to 3050m (Or 10000ft)
- Operating temperature range: -5 °C to +50 °C
- Maximum relative humidity: 95 %rh (non-condensing)
- Pollution degree 2
- Operating voltage: 24 V DC
- Unit power: <25 W
- Ingress Protection: IP55 (***)
- Not for use in corrosive or explosive atmospheres

Features:

- 4x active 4-20mA current signals (max loop resistance of 500Ω, common ground)
- Fault condition \approx 3mA
- 1x MODBUS RTU interface
- Internal buzzer
- Power & fault indications

15.6 CO₂ Sensor performance

NOTE: ALL SPECIFICATIONS ASSUME THE AMBIENT PRESSURE IS 1000MBAR. THE CO₂ SENSOR ACTUALLY MEASURES PARTIAL PRESSURE OF CO₂, NOT CONCENTRATION BY VOLUME.

Parameter	Comments	Min	Max	Units
Range		0	5	% CO ₂
Accuracy		0	5	% of alarm setpoint
Temperature sensitivity	Deviation from calibration temperature		50	PPM/°C
Response time	To 90% of final value	30		Seconds
System warmup time	After power on	40		Seconds

NOTE: ANALOX HAS A POLICY OF CONTINUOUS IMPROVEMENT AND RESERVES THE RIGHT TO UPGRADE OR CHANGE SPECIFICATIONS WITHOUT PRIOR NOTICE.

15.7 O₂ Sensor performance

NOTE: THE AX60+ O₂ SENSOR USES A LEAD-FREE ELECTROCHEMICAL CELL FOR THE DETECTION OF OXYGEN.

Parameter	Comments	Min	Max	Units
Range		0	25	% O ₂
Sensor warmup time	After power on	60		Minutes
Accuracy (<24hrs after power on)	Over full temperature range	±2		% O ₂
Accuracy (>24hrs after power on)	Over full temperature range	±1		% O ₂
Temperature range	Measurement compensated across this range.	-5	50	°C
Response time	To 90% of final value		30	Seconds
Cell life*	Under normal operating conditions	5		Years

NOTE: ANALOX HAS A POLICY OF CONTINUOUS IMPROVEMENT AND RESERVES THE RIGHT TO UPGRADE OR CHANGE SPECIFICATIONS WITHOUT PRIOR NOTICE.

NOTE: CALIBRATION, ANALOX RECOMMENDS A YEARLY CALIBRATION INTERVAL FOR THE OXYGEN SENSOR ALTHOUGH IF HIGHER ACCURACY IS REQUIRED THE SENSOR CAN BE CALIBRATED MORE FREQUENTLY, PLEASE REFER TO THE CALIBRATION SECTION OF THE P0159-803 SERVICE MANUAL.

* - See warranty section for details.

15.8 Product disposal

According to WEEE regulation this electronic product cannot be placed in household waste bins.

Please check local regulations for information on the disposal of electronic products in your area.



16 Warranty

The following Warranty is provided for the Ax60+ multi-gas detector:

- **5-year Warranty, from the date of the original sales invoice (Central Unit, Carbon Dioxide Sensor and Alarm)**
- **2 Year Warranty, from the date of the original sales invoice (Data Output Module)**
- **5 Year Graded Warranty, from the date of the original sales invoice (Oxygen Sensor)**

The Oxygen sensor used in the Ax60+ is a state of the art, long life, low maintenance electrochemical sensor. Due to the sensor technology it will deplete slowly over time so will eventually need replacing which is a simple task which can be carried out by the user, service provider or even returned to Analox if preferred.

The sensor life can vary due to several factors including humidity levels, ambient temperature, the frequency of power ups of the unit and the level of O₂ the sensor is exposed to. Analox are proud to offer an unrivalled 5 year graded warranty on the Oxygen sensor demonstrating our faith in the reliability and life of the sensor.

1 to 2 years: 100% discount off replacement sensor cost

3 years: 75% discount off replacement sensor cost

4 years: 50% discount off replacement sensor cost

5 years: 25% discount off replacement sensor cost

Depending on the circumstances of the installed unit/s the user may wish to carry a spare O₂ Sensor but this sensor will also deplete at a similar rate as it will be exposed to ambient air containing approximately 20.9% O₂.

We warrant that the equipment will be free from defects in workmanship and materials.

The Warranty does not extend to, and we will not be liable for defects caused by the effects of normal wear and tear, erosion, corrosion, fire, explosion, misuse, use in any context or application for which the equipment is not designed or recommended, or unauthorised modification.

The Warranty will be void and shall cease to be effective in the event that any of the sensing elements are tampered with, or in the event that any alterations or repairs are made or attempted, except in accordance with any specific previous written authorisation from us.

Following a valid Warranty Claim in accordance with the above, the equipment, upon receipt, will be repaired, or replaced without cost or charge, but at our discretion, we may elect instead to provide to you whichever is the lesser of the cost of replacement, or a refund of net purchase price paid, as per the original sales invoice.

We shall have no liability for losses, damages, costs or delays whatsoever.

We shall have no liability for any incidental or consequential losses or damages.

All express or implied warranties as to satisfactory or merchantable quality, fitness for a particular or general purpose or otherwise are excluded and no such warranties are made, or provided, save as set out in this Warranty.

In order to effectively notify a Warranty Claim, the claim with all relevant information and documentation should be sent in writing to:

Analox Sensor Technology Limited
15 Ellerbeck Court
Stokesley Business Park
Stokesley
North Yorkshire
TS9 5PT

Or by e-mail to: info@analox.net
Or by fax to: +44 1642 713900

Analox reserves the right to require proof of dispatch to us of the notification of Warranty Claim by any of the above alternative means.

The equipment should not be returned without prior written authority.

All shipping and insurance costs of returned equipment, are at the expense of the customer.

All returned items must be properly and sufficiently packed.

17 Ax60+ UK Declaration of Conformity

UK Declaration of Conformity

Declaration number: P0159-C003-01

Manufacturer's name: Analox Limited

Manufacturer's address: 15 Ellerbeck Court
Stokesley Business Park
Stokesley
North Yorkshire
TS9 5PT

It is declared that the following product:

Product name: Analox AX60+
Product code: AX60Cxxxxxx (Central Display)
AX60Sxxxxxx (Sensor)
AX60Rxxxxxx (Alarm)

Conforms to all applicable requirements of: BS EN50270:2015 (Type 1 Equipment)
BS EN 61000-6-3:2007
BS EN/IEC 61010-1:2010

- Complies with the Electromagnetic Compatibility Regulations 2016
- The Electrical Equipment (Safety) Regulations 2016
- Complies with the requirements of UK RoHS 2012
- Complies with the requirements of WEEE Regulations 2013

The above product is UKCA-marked and satisfies the relevant legislative requirements of the UK



Signed on behalf of: Analox Limited

Date: 10th October 2022

Signed: 

Name: Paul Branton
Position: Technical Director

18 Ax60+ Declaration of Conformity

Declaration of conformity

Declaration number: P0159-905-06

Manufacturer's name: Analox Sensor Technology Limited

Manufacturer's address: 15 Ellerbeck Court
Stokesley Business Park
Stokesley
North Yorkshire
TS9 5PT

It is declared that the following product:

Product name: Analox AX60+
Product code: AX60Cxxxxxx (Central Display)
AX60Sxxxxxx (Sensor)
AX60Rxxxxxx (Alarm)

Conforms to all applicable requirements of: BS EN50270:2015 (Type 1)
EN 61000-6-3:2007
FCC to class B levels according to title
47 of the Code of Federal Regulations
(CFR) part 15 (47CFR15):2008
EN/IEC 61010-1:2010 (UL)
DIN 6653-2:2015 (TUV)
AS 5034:2005

- The above product complies with the requirements of the EMC Directive 2014/30/EU
- The above product complies with the requirements of the Low Voltage Directive 2014/35/EU, as amended
- The above product complies with the requirements of the RoHS2 Directive 2011/65/EU
- The above product complies with the requirements of the WEEE Directive 2012/19/EU

UL The above product is certified by UL for use in the USA and Canada, file number E467381



TUV The above product is certified by TUV to comply with DIN 6653-2:2015 certificate reference ID 0000043715



FCC The above product is approved by FCC to class B levels according to title 47 of the Code of Federal Regulations (CFR) part 15 (47CFR15):2008



CE The above product is CE-marked and satisfies the relevant legislative requirements of the European Economic Area (EEA)



Signed on behalf of: Analox Sensor Technology Limited

Date: 10th October 2022

Signed:

Name: Paul Branton

Position: Technical Director

19 Ax60+ Data Output Module Declaration of Conformity

Declaration of Conformity

Declaration number: P0159-911-01

Manufacturer's name: Analox Sensor Technology Limited

Manufacturer's address: 15 Ellerbeck Court
Stokesley Business Park
Stokesley
North Yorkshire
TS9 5PT

It is declared that the following product:

Product name: Analox AX60+

Product code: AX600Mxxxxx (Data Output Module)

Conforms to all applicable requirements of: EN50270:2015 for Type 1 Equipment
EN 61000-6-3:2007 + A1:2011
FCC to class A levels according to title
47 of the Code of Federal Regulations
(CFR) part 15
EN/IEC 61010-1:2010 (UL)
AS 5034:2005

- The above product complies with the requirements of the EMC Directive 2014/30/EU
- The above product complies with the requirements of the Low Voltage Directive 2014/35/EU, as amended
- The above product complies with the requirements of the RoHS2 Directive 2011/65/EU
- The above product complies with the requirements of the WEEE Directive 2012/19/EU

UL The above product is approved for use in the
USA and Canada, file number E467381

FCC The above product is approved by FCC to class
A levels according to title 47 of the Code of
Federal Regulations (CFR) part 15 (47CFR15)

CE The above product is CE-marked and satisfies
the relevant legislative requirements of the
European Economic Area (EEA)



Signed on behalf of: Analox Sensor Technology Limited

Date: 9th May 2018

Signed:

A handwritten signature in blue ink, appearing to read 'Mark Lewis', is written over a horizontal line.

Name: Mark Lewis
Position: Managing Director